

- STANDART PROFİLLER

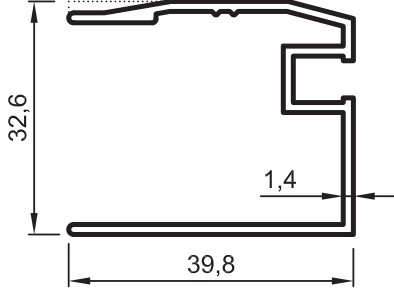

No : 5199 (*)
Sineklik Profili
0,490 kg/m

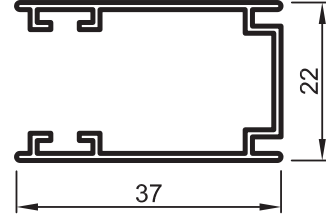

No : 5702
Sineklik Profili
0,330 kg/m

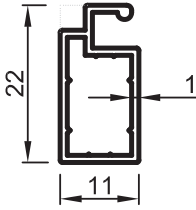

No : 2554
Küçük Sineklik
0,190 kg/m

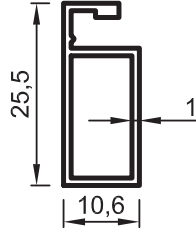

No : 5159
Küçük Sineklik
0,210 kg/m

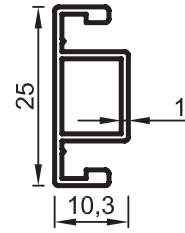

No : 6581
Sineklik Profili
0,215 kg/m

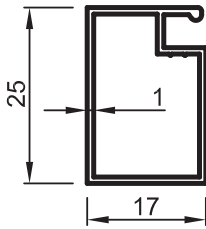

No : 3263
Büyük Sineklik
0,210 kg/m

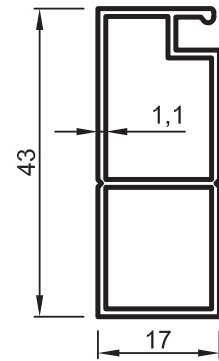

No : 3916
Büyük Sineklik
0,415 kg/m

(*) Sipariş miktarı 300 kg dır./ (*) Minimum order quality: 300 kg

Uyarı: Profil ağırlıklarımız teorik olup; teslim anındaki tartımız geçerlidir.

Warning: The weights of profile is theoretical, weighting at the time of delivery are valid.

- STANDART PROFİLLER

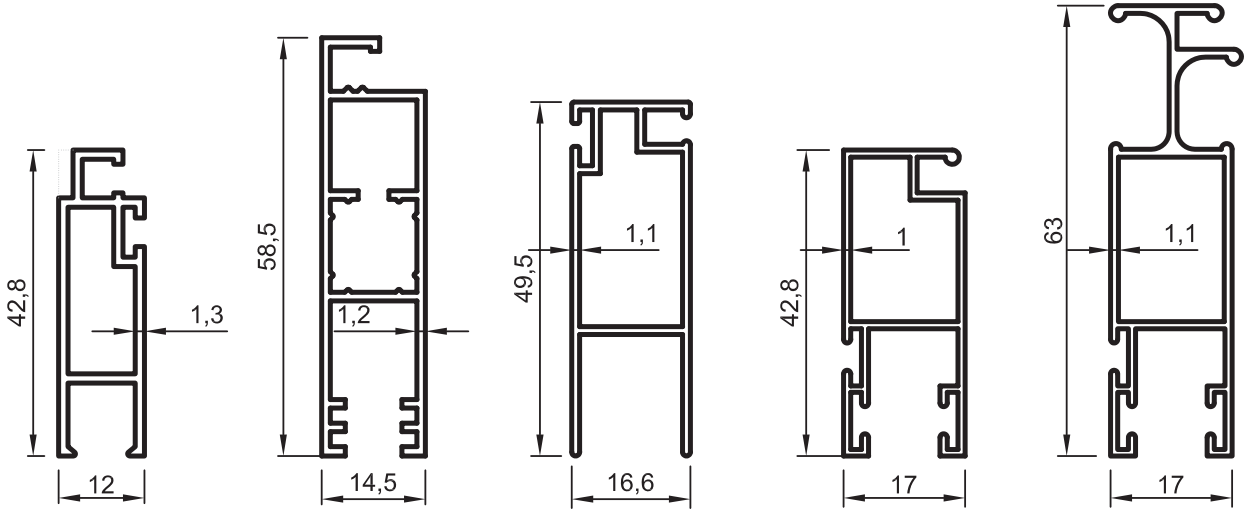

No : 2780

Sineklilik Profili
0,400 kg/m

No : 7031

Sineklilik Profili
0,545 kg/m

No : 12449

Sineklilik Profili
0,430 kg/m

No : 11871

Sineklilik Profili
0,390 kg/m

No : 12955

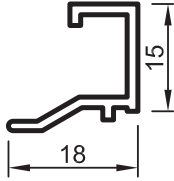
Sineklilik Profili
0,560 kg/m

No : 1810

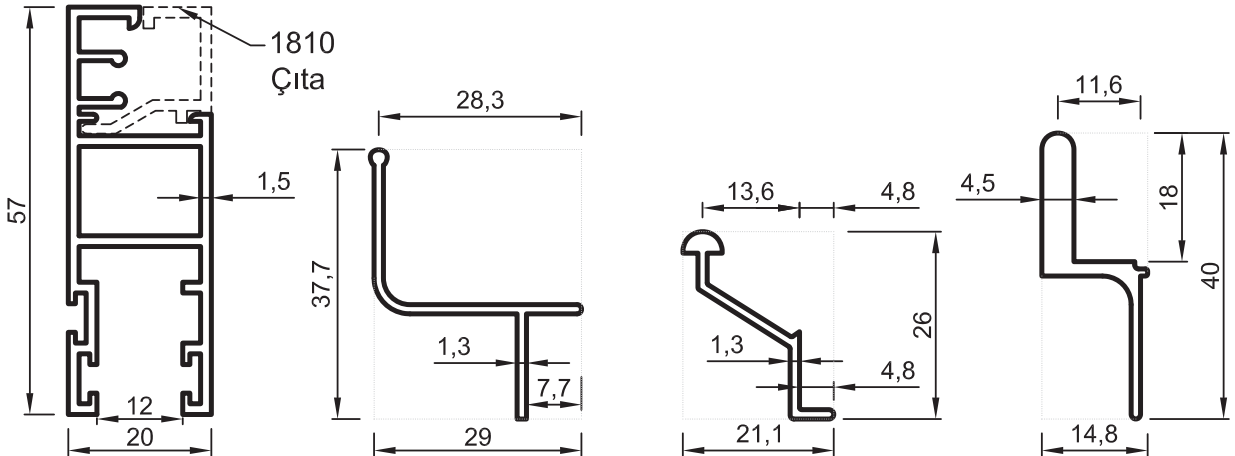
Sineklilik Çıtası
0,180 kg/m

No : 1809

Sineklilik Kanadı
0,730 kg/m

No : 7023

Sineklilik Ray Profili
0,230 kg/m

No : 1821

Sineklilik Ray
0,170 kg/m

No : 1823

Sineklilik Ray
0,380 kg/m

Uyarı: Profil ağırlıklarımız teorik olup; teslim anındaki tartımız geçerlidir.

Warning: The weights of profile is theoretical, weighting at the time of delivery are valid.

• STANDART PROFİLLER

No : 1824
0,825 kg/m

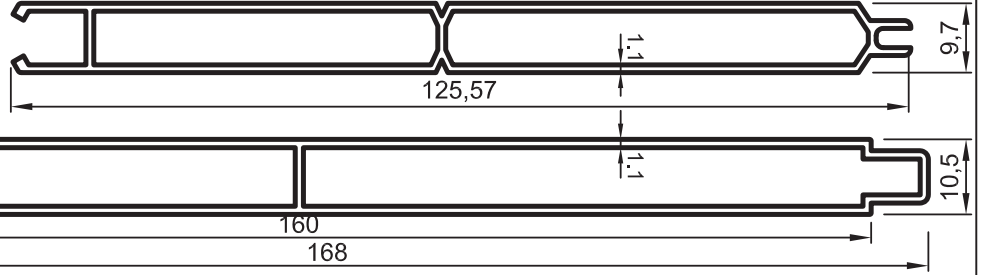

(*) Sipariş miktarı en az 300 kg olmalıdır.

No : 1851-1
1,125 kg/m

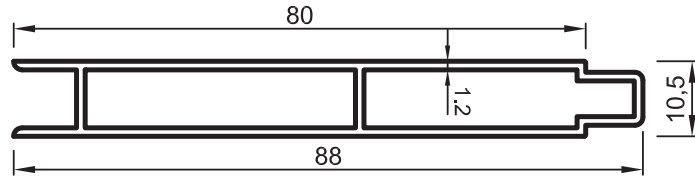

No : 1851
0,625 kg/m

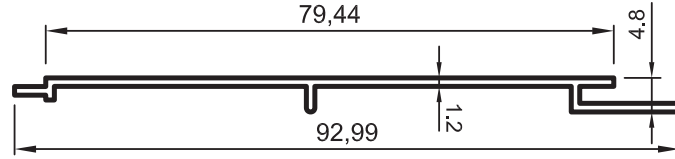

No : 1852 (*)
0,350 kg/m

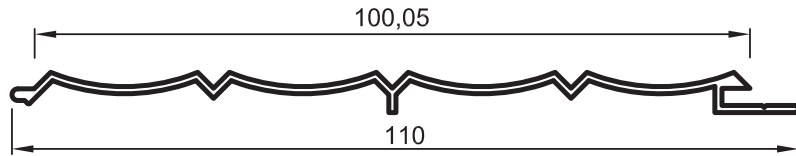

No : 1853
0,360 kg/m

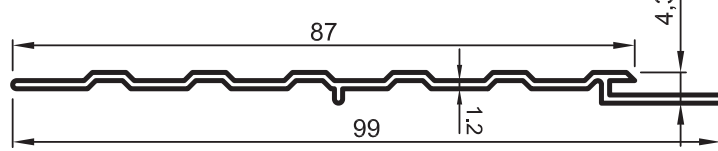

No : 1854 (*)
0,355 kg/m

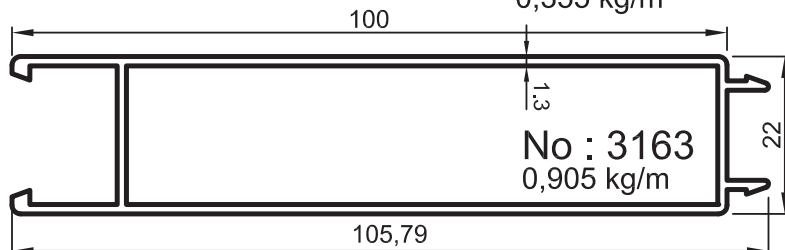

No : 4677 (*)
1,015 kg/m

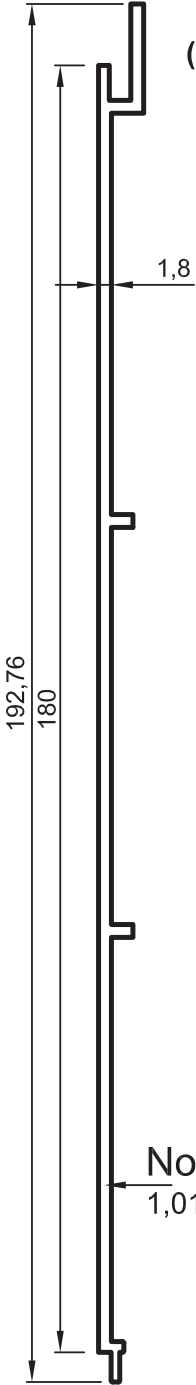

No : 3163
0,905 kg/m

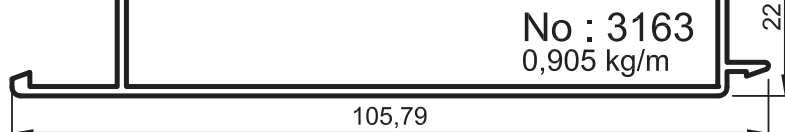

Uyarı: Profil ağırlıklarımız teorik olup; teslim anındaki tartımız geçerlidir.

Warning: The weights of profile is theoretical, weighting at the time of delivery are valid.