

SARAY[®] | ROLL

PANJUR SİSTEMLERİ
ROLLER SHUTTER SYSTEMS

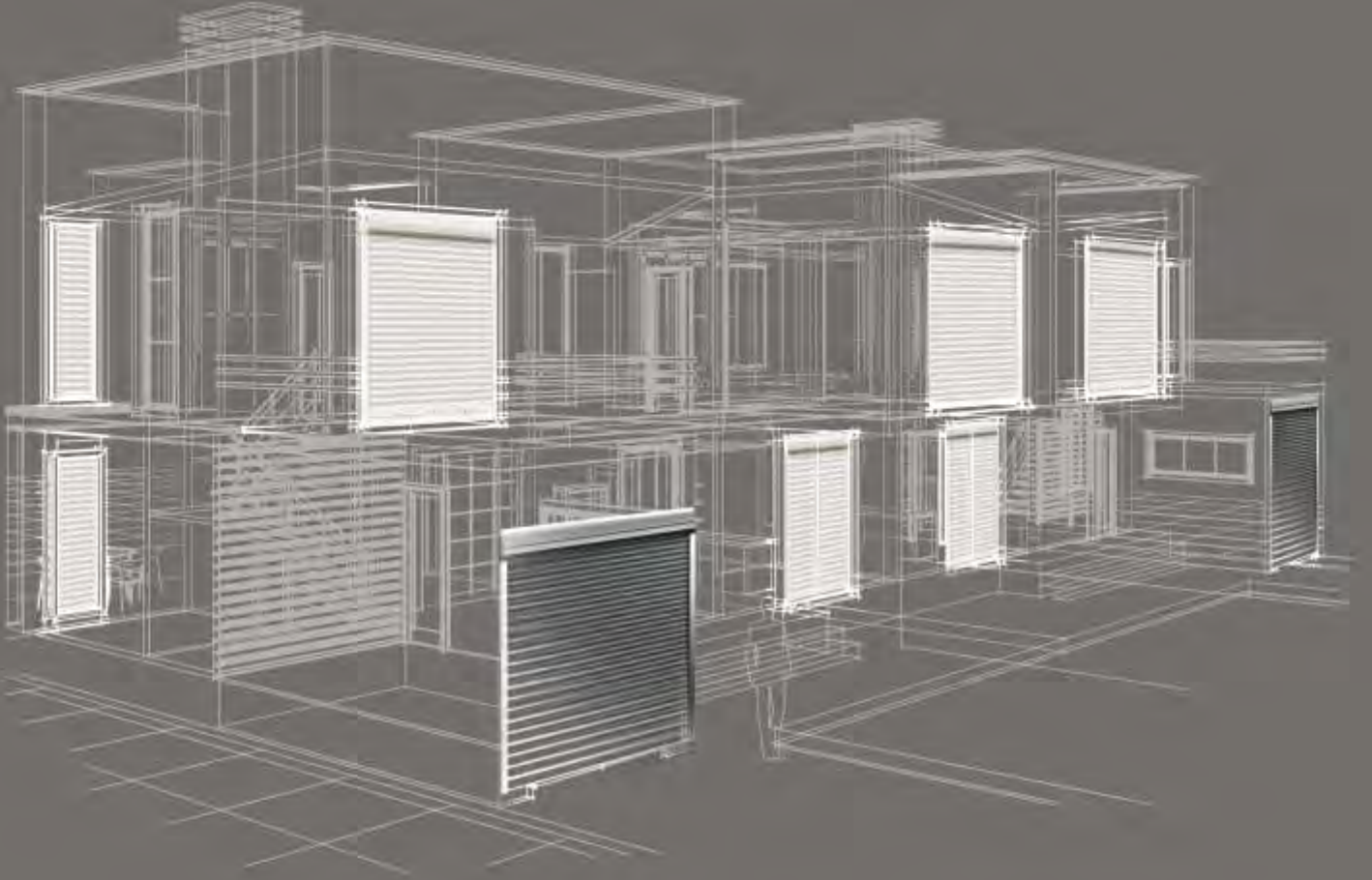

SARAY[®]

PANJUR SİSTEMLERİ ROLLER SHUTTER SYSTEMS

İÇİNDEKİLER INDEX	SAYFA PAGE
ŞİRKET PROFİLİ COMPANY PROFILE	04
SARAYROLL HAKKINDA ABOUT SARAYROLL	05
POLİÜRETAN DOLGULU ALÜMİNYUM LAMELLER ALUMINIUM SLATS WITH POLYURETHANE	10
ALÜMİNYUM EKSTRÜZYON LAMELLER ALUMINIUM EXTRUDED SLATS	18
ALT PARÇALAR END SLATS	28
DİKMELER GUIDE RAILS	36
BORULAR TUBES	46
ALÜMİNYUM KUTULAR ALUMINIUM BOXES	50
AKSESUARLAR ACCESSORIES	60
S-MONOBLOCK S-MONOBLOCK	76
S-MOTOR S-MOTOR	92



Şirket Profili

Saray Alüminyum 1980'den bu yana, geliştirdiği öncü ve yenilikçi iç ve dış cephe çözümleriyle geleceğin mimari yapılarının inşa edilmesinde büyük rol oynuyor.

Saray Alüminyum kapı, pencere, cephe ve küpeşte sistemleri, alüminyum kompozit panel, PVC kapı ve pencere sistemleri, panjur sistemleri ve makina, aydınlatma, asansör vb. sektörlerinin ihtiyacı olan çeşitli şekil ve büyüklükte sanayi profilleri ve standart kesitli profiller üretiyor.

Türkiye'nin ilk 200 şirketi arasında yer alan Saray Alüminyum, üretiminin %35'ini Avrupa, Afrika ve Asya'da 50'yi aşkın ülkeye ihraç ediyor, yüksek ihracat rakamları ile her yıl İhracatın Yıldızları ödülünü alıyor.

CE, ISO 9001, Qualanaod, Qualicoat, TS EN 755, TS EN 12020, SEPRO ve GOST-R kalite belgelerine sahip olan Saray Alüminyum, İstanbul Güneşli ve Tekirdağ Çerkezköy'de, toplam 100 bin m² kapalı alanda üretim yapıyor. Saray bünyesinde, alüminyum toz boya, alüminyum eloksall kaplama, ekstrüzyon, biyet döküm, alüminyum kompozit panel, panjur, pvc ekstrüzyon üretim tesislerinin yer aldığı tam entegre bir kuruluş.

Proje ve AR-GE birimleriyle mimari ofislere ve yapı yatırımcılarına cephe tasarımından uygulamasına, tüm aşamalarda teknik destek veren, çok katlı ve nitelikli yapılar için özel cephe çözümleri sunan Saray Alüminyum, geliştirdiği yüksek performanslı inovatif ürünlerle, geleceğin mimari yapılarının inşa edilmesinde, yaşam kalitesinin yükseltilmesinde önemli rol oynuyor.

Company Profile

Since 1980, Saray Aluminum has been playing a major role in the construction of future architectural buildings with its leading and innovative interior, exterior construction solutions.

Saray manufactures Aluminum door&window, facade and handrail systems, aluminum composite panel, PVC door&window systems, shutter Systems, various types of industrial profiles for the sectors such as machinery, lighting, elevator etc. and standard section profiles in various shapes and sizes.

Saray is among the first Turkey's Top 200 Industrial Enterprises and exports %35 of total production more than 50 countries in Europe, Asia, Africa; with its high export amounts Saray receives the "Export Stars of Turkey" award in every year.

Saray Aluminium has CE, ISO 9001, Qualanaod, Qualicoat, TS EN 755, TS EN 12020, SEPRO and GOST-R quality certificates. Saray is a fully integrated enterprise with its aluminum powder coating, aluminum anodizing, extrusion, casting, aluminum composite panel and pvc extrusion, shutter production facilities. With a total of 100.000 sqm covered area, production facilities are located in Cerkezkoy/Tekirdag and Gunesli/Istanbul.

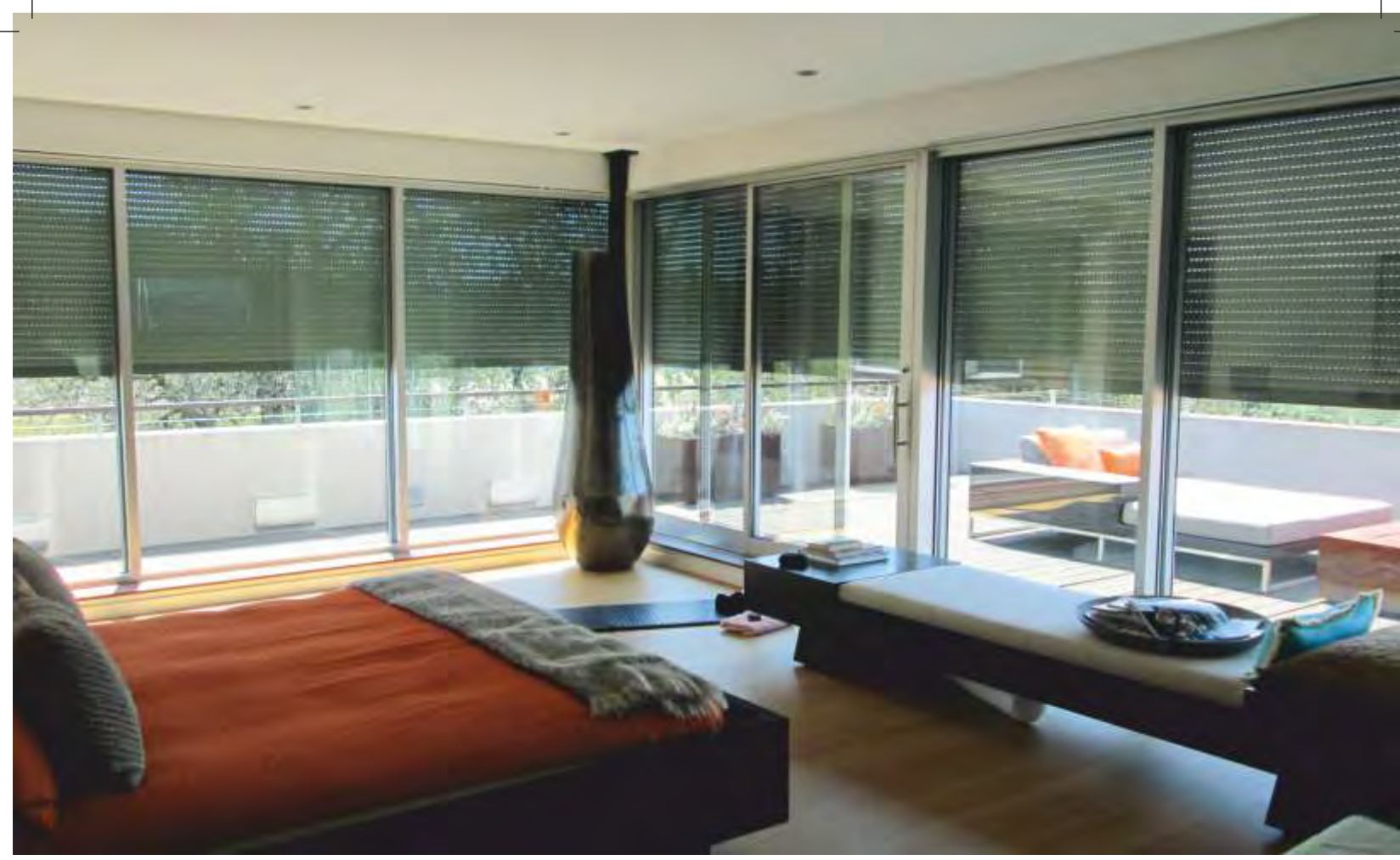

SARAYROLL Hakkında...

Bugün dünyadaki toplam enerji tüketiminin % 39'u evlerimizin soğutulması ve ısıtılması için kullanılıyor. Konutlarda ısı yalıtımında sağlanan en ufak bir iyileştirme dahi, yalnız enerji tüketimimizi düşürerek dünyamızın geleceğine katkıda bulunmamızı değil, aynı zamanda tasarruf etmemizi de sağlar.

Yapılarda ısı transferini en aza indirmek için dikkat edilmesi gereken temel unsurlardan biri de panjur seçimidir. Pencereler, hemen her zaman ısı kaybının en yoğun olduğu bölgelerdir. Çünkü fizik kanunlarına göre, ısı her zaman, yüksek sıcaklık bölgelerinden düşük sıcaklıktaki bölgelere doğru yönelir. Bu nedenle iç mekândaki sıcaklık, daha düşük derecedeki dış mekâna doğru pencerelerden hareket eder.

Saray'ın alüminyum profil üretimindeki geniş deneyimi, size panjurla ilgili tüm ihtiyaçlarınızı karşılayacak, yüksek kaliteli, inovatif ürünlerden oluşan kapsamlı bir katalog sunmamızı sağlıyor. Güneşten koruyan, ses ve ısı transferini azaltan, yüksek performansa sahip poliüretan dolgulu alüminyum lameller, ekstrüde edilmiş alüminyum lameller, çeşitli yardımcı alüminyum panjur profilleri ve kullanılan aksesuarlar geniş ürün yelpazemizi oluşturuyor.

Her biri, hem ısı ve ses yalıtımı, hem de montaj kolaylığı sunacak şekilde tasarlanmış PVC monoblok kutular ve ekstrüde edilmiş alüminyum kutular ise bu geniş yelpazeyi tamamlıyor.

About SARAYROLL...

39% of the world's total energy consumption is used to cool and heat our houses. Any improvements made due to insulation allows us not only to contribute to the future of our world by reducing our energy consumption, but also to save money at the same time.

Choosing a good shutter is essential for buildings which will prevent and reduce the transmission of heat. The windows are the areas where heat loss is most intense. According to the laws of physics, heat always moves from areas of high temperature to those at a lower temperature therefore in the cold external temperatures, the warmth inside a building will try to escape through windows.

Saray's extensive experience in manufacturing aluminium profiles, PVC profiles, shutter profiles, enables us to offer an extensive catalogue that will meet your requirements about shutters. We offer a wide range; top performance polyurethane filled aluminium slats, extruded aluminium shutters, various types of aluminium auxiliary profiles and accessories, that protect from the sun, reduce sound and heat transfer.

Innovative high quality PVC Monoblock boxes and extruded aluminium boxes designed to provide both heat and sound insulation as well as ease of assembly, complete this wide range.

*SARAYROLL' ile
Evinizde Rahatlığın Keyfini Çıkartın...*



*with SARAYROLL
Enjoy the comfort at home*



GÜNEŞİN ZARARLARINDA KORUNMA

Tüm Panjur profillerimiz Ultraviyole ışınlarının yapının içine girmesini engellemektedir.

SUN PROTECTION

All our Shutter Profiles prevent the penetration of ultra-violet rays into the building.



AKUSTİK (SES) KORUMA

Panjurlarımız dış ortamdaki gürültüye karşı da koruma sağlar.

ACOUSTIC PROTECTION

Our shutters also provide protection against external noise.



ENERJİ TASARRUFU VE SÜRDÜRÜLEBİLİRLİK

Saray sistem panjurları, enerji harcamalarınızı düşürür ve pencerelerinizden istenmeyen soğuk veya sıcak ısı transferini önler. Genişletilmiş poliüretan ile doldurulmuş profillerimiz enerji sarfiyatını azaltır.

ENERGY SAVING AND SUSTAINABILITY

Saray shutter systems reduce energy expenses by preventing undesirable transmissions of cold or heat through your windows.

Our extensive range of profiled slats, filled with expanded polyurethane, will lower the energy consumption .

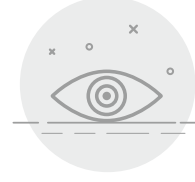

GİZLİLİK

Panjurlar ihtiyaç hissettiğinizde size mahremiyet sağlar. Delikli veya Mikro-Delikli lamel seçenekleri gün ışığının ve havanın geçişine izin verir odanın ventilasyonuna da olanak sağlar.

PRIVACY

Shutters provide privacy when you need it. Micro-perforated or perforated slat options allow the entry of light and air and provide ventilation for your room.



ÇOKLU RENKLER

Farklı ebat, model ve renklere sahip lamel ve kutulardan oluşan geniş ürün yelpazemiz sizlere daha iyi hizmet verebilmemizi sağlar.

MULTIPLE COLOURS

The wide range of models, sizes, colours in all our slats and models of boxes enable us to serve you better.



GÜVENLİK

Panjur sistemlerinin en önemli özelliklerinden birisi de hırsızlığa karşı evinizin güvenliğini sağlamasıdır.

SECURITY

One of the most important feature of a shutter is to provide security against theft.

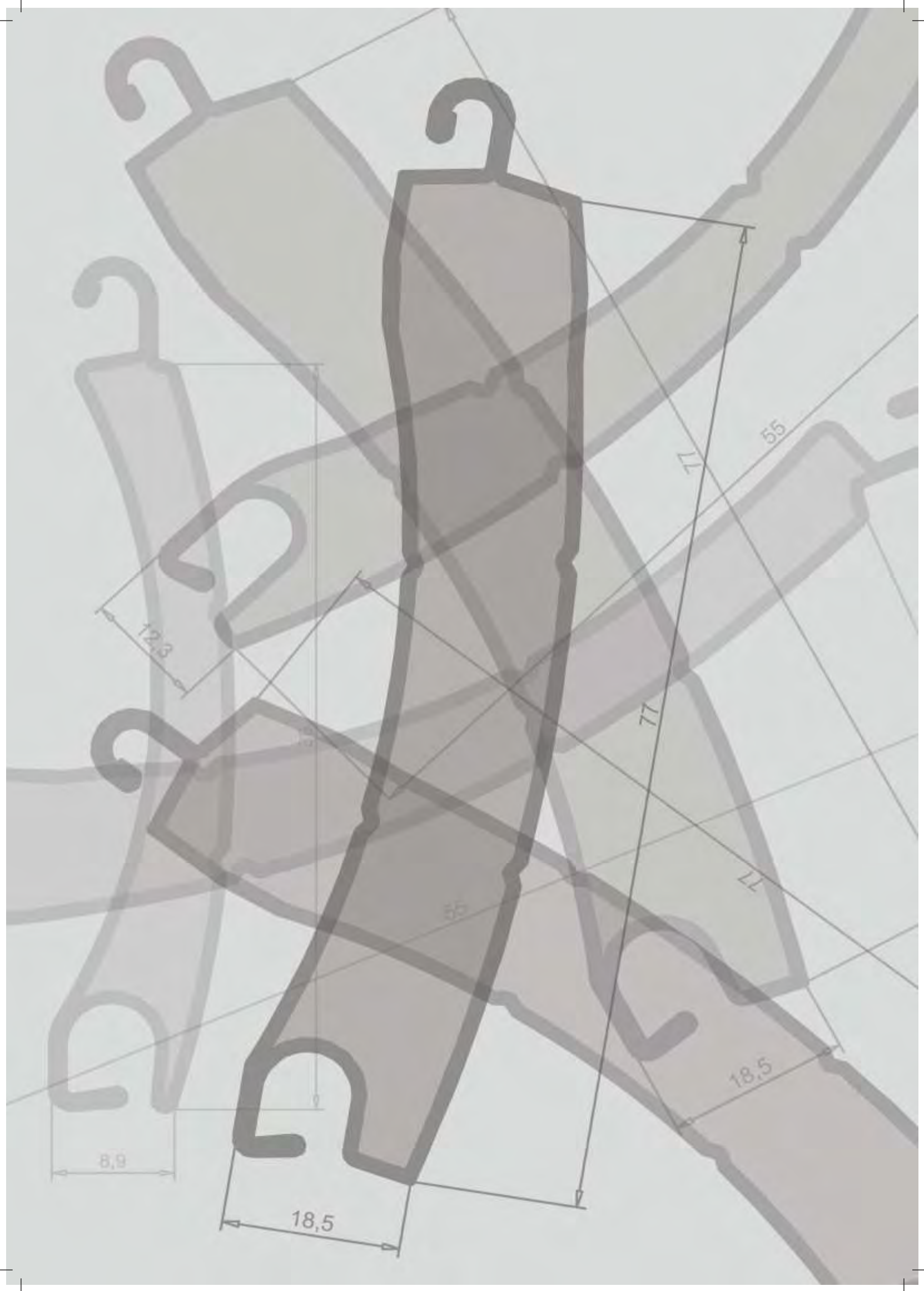

12,3

8,9

18,5

77

55

77

77

18,5

55

SARAY[®] | ROLL

ALÜMİNYUM POLİÜRETAN DOLGULU LAMELLER
ALUMINIUM POLYURETHANE FOAMED SLATS

39
mm

Standart Yoğunlukta Poliüretan Dolgulu Alüminyum 39 mm Delikli Lamel

Standard Density Polyurethane Foamed Perforated 39 mm Aluminium Slat

Özellikler / Properties

Metre Ağırlığı Weight per Meter	0,100 kg/m
Metrekare Ağırlığı Weight per Square Meter	2,570 kg/m ²
Bir Metre Yükseklikteki Lamel Sayısı Number of Slats per one meter height	26 adet / pieces
Tavsiye Edilen Azami En Maximum Recommended Width	2.600 mm
Tavsiye Edilen Azami Yükseklik Maximum Recommended Height	2.600 mm
Standart Üretim Boyu Standart Manufacturing Length	6.500 mm
Paketteki Adet Pieces per Package	50 adet / pieces (325 m)

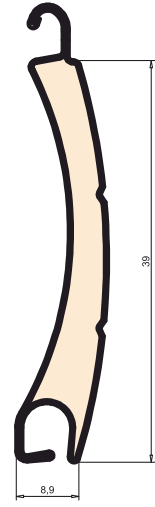

Kodlar / Codes

SAP.039.SD.9016



SAP.039.SD.9006



SAP.039.SD.7016



SAP.039.SD.9500



SAP.039.SD.9501



SAP.039.SD.8014



SAP.039.SD.0001



SAP.039.SD.0002



SAP.039.SD.XXXX



(XXXX Ral codu yazınız, Write Ral Code)

Renkler / Colors

Beyaz / White

Metalik Gri / Metallic Grey

Antrasit Gri / Anthracite

Şampanya / Champagne

Bronz / Bronze

Kahverengi / Brown

Altın Meşe / Golden Oak

Ceviz / Walnut

Özel Ral Renkler / Special Ral Colors

55
mm

Standart Yoğunlukta Poliüretan Dolgulu Alüminyum 55 mm Delikli Lamel

Standard Density Polyurethane Foamed Perforated 55 mm Aluminium Slat

Özellikler / Properties

Metre Ağırlığı Weight per Meter	0,150 kg/m
Metrekare Ağırlığı Weight per Square Meter	2,7000 kg/m ²
Bir Metre Yükseklikteki Lamel Sayısı Number of Slats per one meter height	18 adet / pieces
Tavsiye Edilen Azami En Maximum Recommended Width	3.000 mm
Tavsiye Edilen Azami Yükseklik Maximum Recommended Height	2.700 mm
Standart Üretim Boyu Standart Manufacturing Length	6.500 mm
Paketteki Adet Pieces per Package	20 adet / pieces (130 m)

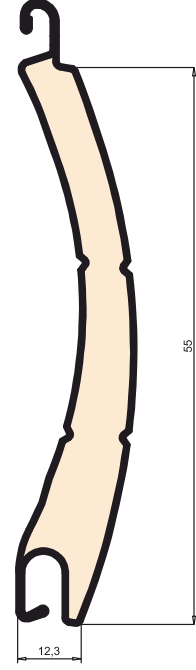

Kodlar / Codes

SAP.055.SD.9016



SAP.055.SD.9006



SAP.055.SD.7016



SAP.055.SD.9500



SAP.055.SD.9501



SAP.055.SD.8014



SAP.055.SD.0001



SAP.055.SD.0002



SAP.055.SD.XXXX



(XXXX Ral codu yazınız, Write Ral Code)

Renkler / Colors

Beyaz / White

Metalik Gri / Metallic Grey

Antrasit Gri / Anthracite

Şampanya / Champagne

Bronz / Bronze

Kahverengi / Brown

Altın Meşe / Golden Oak

Ceviz / Walnut

Özel Ral Renkler / Special Ral Colors

55
mm

Yüksek Yoğunlukta Poliüretan Dolgulu Alüminyum 55 mm Delikli Lamel
High Density Polyurethane Foamed Perforated 55 mm Aluminium Slat

■ **Özellikler / Properties**

Metre Ağırlığı Weight per Meter	0,195 kg/m
Metrekare Ağırlığı Weight per Square Meter	3,500 kg/m ²
Bir Metre Yükseklikteki Lamel Sayısı Number of Slats per one meter height	18 adet / pieces
Tavsiye Edilen Azami En Maximum Recommended Width	3.000 mm
Tavsiye Edilen Azami Yükseklik Maximum Recommended Height	2.700 mm
Standart Üretim Boyu Standart Manufacturing Length	6.500 mm
Paketteki Adet Pieces per Package	20 adet / pieces (130 m)

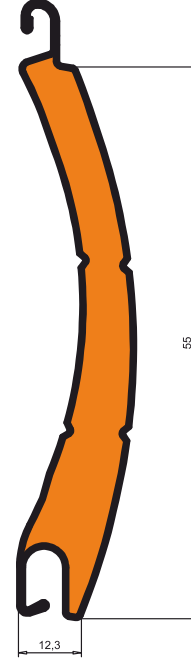

■ **Kodlar / Codes**

SAP.055.HD.9016



SAP.055.HD.9006



SAP.055.HD.7016



SAP.055.HD.9500



SAP.055.HD.9501



SAP.055.HD.8014



SAP.055.HD.0001



SAP.055.HD.0002



SAP.055.HD.XXXX



(XXXX Ral codu yazınız, Write Ral Code)

■ **Renkler / Colors**

Beyaz / White

Metalik Gri / Metallic Grey

Antrasit Gri / Anthracite

Şampanya / Champagne

Bronz / Bronze

Kahverengi / Brown

Altın Meşe / Golden Oak

Ceviz / Walnut

Özel Ral Renkler / Special Ral Colors

77
mm

Standart Yoğunlukta Poliüretan Dolgulu Alüminyum 77 mm Deliksiz Lamel

Standard Density Polyurethane Foamed Non Perforated 77 mm Aluminium Slat

Özellikler / Properties

Metre Ağırlığı Weight per Meter	0,360 kg/m
Metrekare Ağırlığı Weight per Square Meter	4,800 kg/m ²
Bir Metre Yükseklikteki Lamel Sayısı Number of Slats per one meter height	13 adet / pieces
Tavsiye Edilen Azami En Maximum Recommended Width	5.000 mm
Tavsiye Edilen Azami Yükseklik Maximum Recommended Height	3.000 mm
Standart Üretim Boyu Standart Manufacturing Length	6.000 mm
Paketteki Adet Pieces per Package	10 adet / pieces (60 m)

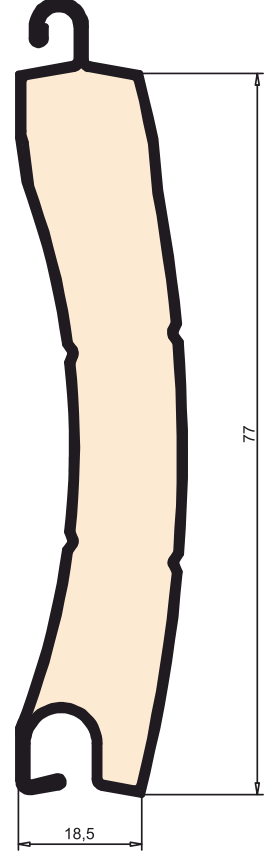

Kodlar / Codes

SAP.077.SZ.9016



SAP.077.SZ.9006



SAP.077.SZ.7016



SAP.077.SZ.9500



SAP.077.SZ.9501



SAP.077.SZ.8014



SAP.077.SZ.0001



SAP.077.SZ.0002



SAP.077.SZ.XXXX



(XXXX Ral codu yazınız, Write Ral Code)

Renkler / Colors

Beyaz / White

Metalik Gri / Metallic Grey

Antrasit Gri / Anthracite

Şampanya / Champagne

Bronz / Bronze

Kahverengi / Brown

Altın Meşe / Golden Oak

Ceviz / Walnut

Özel Ral Renkler / Special Ral Colors

77
mm

Yüksek Yoğunlukta Poliüretan Dolgulu Alüminyum 77 mm Deliksiz Lamel

High Density Polyurethane Foamed Non Perforated 77 mm Aluminium Slat

Özellikler / Properties

Metre Ağırlığı Weight per Meter	0,550 kg/m
Metrekare Ağırlığı Weight per Square Meter	7,150 kg/m ²
Bir Metre Yükseklikteki Lamel Sayısı Number of Slats per one meter height	13 adet / pieces
Tavsiye Edilen Azami En Maximum Recommended Width	5.000 mm
Tavsiye Edilen Azami Yükseklik Maximum Recommended Height	3.000 mm
Standart Üretim Boyu Standart Manufacturing Length	6.000 mm
Paketteki Adet Pieces per Package	10 adet / pieces (60 m)

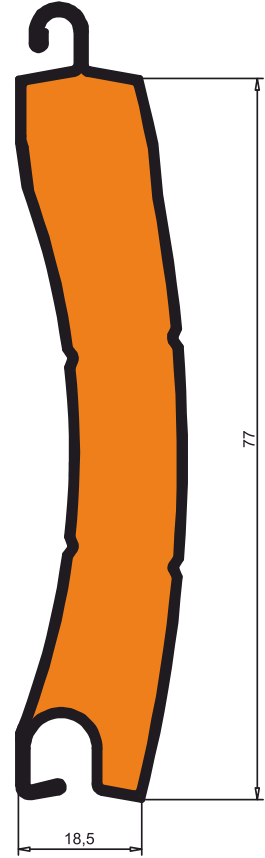

Kodlar / Codes

SAP.077.HZ.9016



SAP.077.HZ.9006

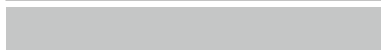

SAP.077.HZ.7016



SAP.077.HZ.9500

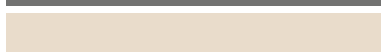

SAP.077.HZ.9501



SAP.077.HZ.8014



SAP.077.HZ.0001



SAP.077.HZ.0002



SAP.077.HZ.XXXX



(XXXX Ral codu yazınız, Write Ral Code)

Renkler / Colors

Beyaz / White

Metalik Gri / Metallic Grey

Antrasit Gri / Anthracite

Şampanya / Champagne

Bronz / Bronze

Kahverengi / Brown

Altın Meşe / Golden Oak

Ceviz / Walnut

Özel Ral Renkler / Special Ral Colors

77
mm

Standart Yoğunlukta Poliüretan Dolgulu Çelik 77 mm Deliksiz Lamel

Standart Density Polyurethane Foamed Steel 77 mm Non Perforated Slat

Özellikler / Properties

Metre Ağırlığı Weight per Meter	0,820 kg/m
Metrekare Ağırlığı Weight per Square Meter	10,660 kg/m ²
Bir Metre Yükseklikteki Lamel Sayısı Number of Slats per one meter height	13 adet / pieces
Tavsiye Edilen Azami En Maximum Recommended Width	5.500 mm
Tavsiye Edilen Azami Yükseklik Maximum Recommended Height	3.500 mm
Standart Üretim Boyu Standart Manufacturing Length	6.000 mm
Paketteki Adet Pieces per Package	10 adet / pieces (60 m)

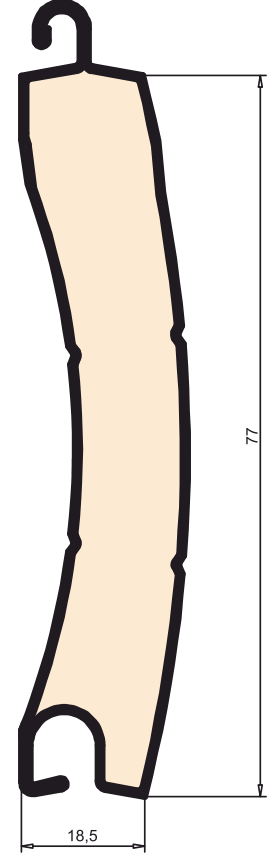

Kodlar / Codes

SGP.077.SZ.9016

SGP.077.SZ.9006

SGP.077.SZ.7016



Renkler / Colors

Beyaz / White

Metalik Gri / Metallic Grey

Antrasit Gri / Anthracite

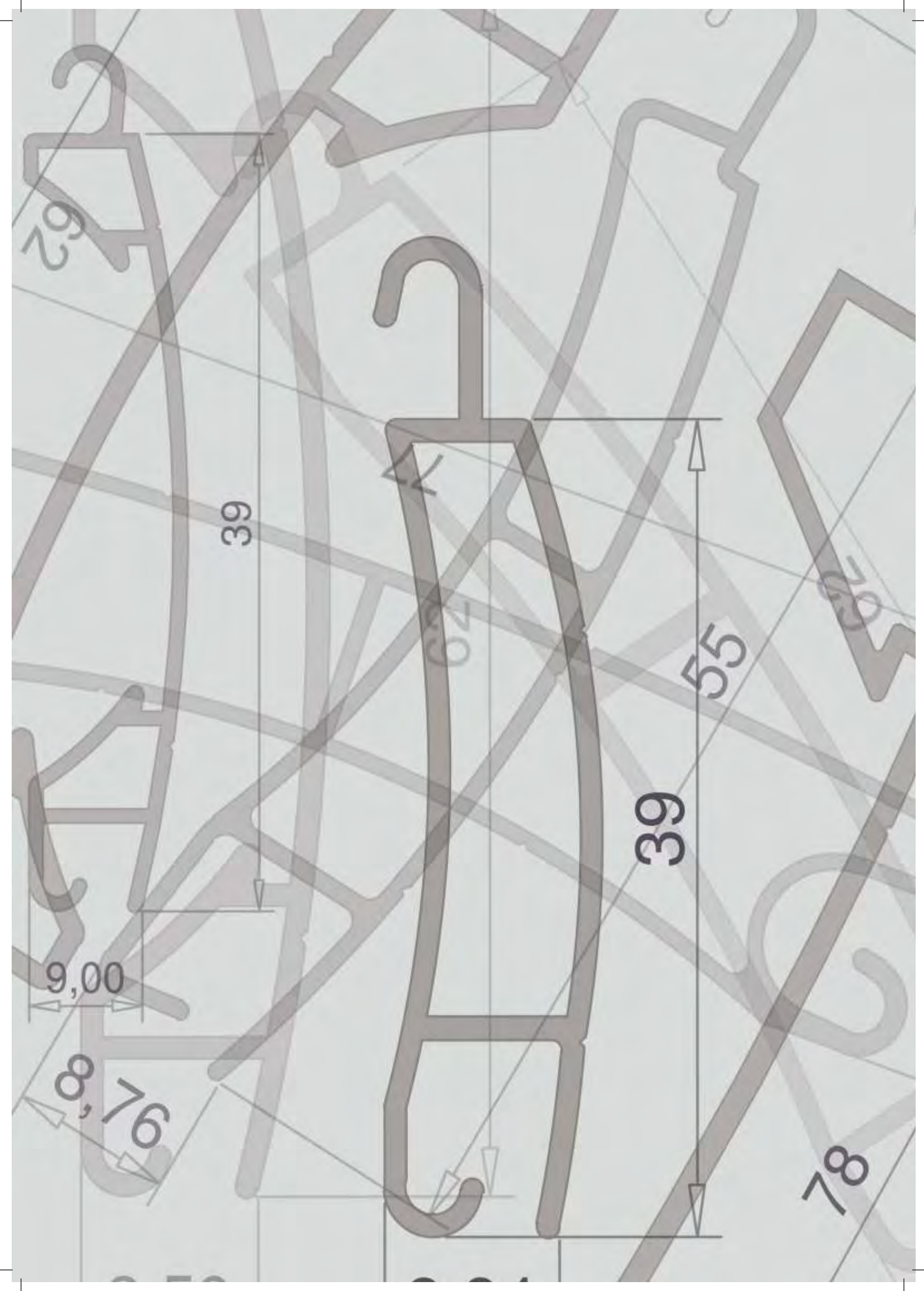

62

39

9,00

7,6

K

62

39

55

78

62

SARAY[®] | ROLL

ALÜMİNYUM EKSTRÜZYON LAMELLER
ALUMINIUM EXTRUDED SLATS



39
mm

Alüminyum Tek Duvarlı 39 mm Lamel Deliksiz

Aluminium Single Wall 39 mm Slat, Non Perforated

Özellikler / Properties

Metre Ağırlığı Weight per Meter	0,280 kg/m
Metrekare Ağırlığı Weight per Square Meter	7,18 kg/m ²
Bir Metre Yükseklikteki Lamel Sayısı Number of Slats per one meter height	25 adet / pieces
Tavsiye Edilen Azami En Maximum Recommended Width	2.600 mm
Tavsiye Edilen Azami Yükseklik Maximum Recommended Height	2.200 mm
Standart Üretim Boyu Standart Manufacturing Length	6.500 mm
Paketteki Adet Pieces per Package	5 adet / pieces (32,5 m)

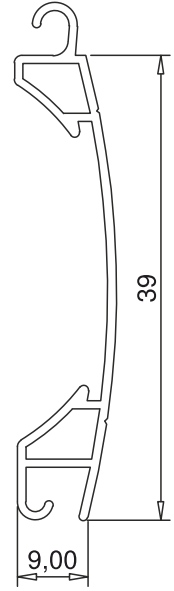

Kodlar / Codes

SAE.039.TZ.0000

SAE.039.TZ.9016

SAE.039.TZ.9006

SAE.039.TZ.7016

SAE.039.TZ.9500

SAE.039.TZ.9501

SAE.039.TZ.8014

SAE.039.TZ.XXXX

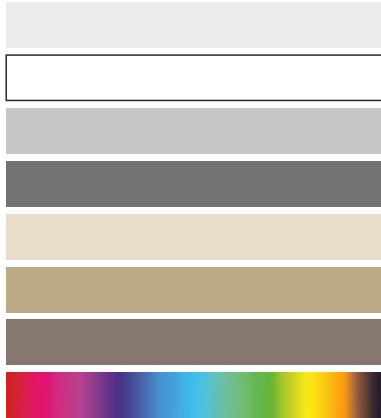

(XXXX Ral codu yazınız, Write Ral Code)

Renkler / Colors

Pres / Mill Finish

Beyaz / White

Metalik Gri / Metallic Grey

Antrasit Gri / Anthracite

Şampanya / Champagne

Bronz / Bronze

Kahverengi / Brown

Özel Ral Renkler / Special Ral Colors

39
mm

Alüminyum Çift Duvarlı 39 mm Lamel Deliksiz

Aluminium Double Wall 39 mm Slat, Non Perforated

Özellikler / Properties

Metre Ağırlığı Weight per Meter	0,340 kg/m
Metrekare Ağırlığı Weight per Square Meter	8,700 kg/m ²
Bir Metre Yükseklikteki Lamel Sayısı Number of Slats per one meter height	25 adet / pieces
Tavsiye Edilen Azami En Maximum Recommended Width	2.600 mm
Tavsiye Edilen Azami Yükseklik Maximum Recommended Height	2.200 mm
Standart Üretim Boyu Standart Manufacturing Length	6.500 mm
Paketteki Adet Pieces per Package	5 adet / pieces (32,5 m)

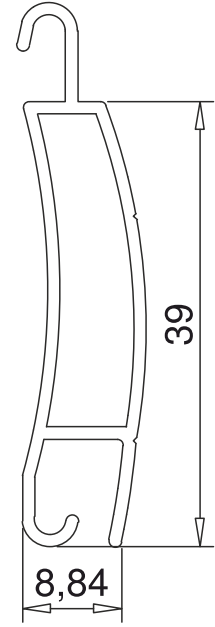

Kodlar / Codes

SAE.039.CZ.0000

SAE.039.CZ.9016

SAE.039.CZ.9006

SAE.039.CZ.7016

SAE.039.CZ.9500

SAE.039.CZ.9501

SAE.039.CZ.8014

SAE.039.CZ.XXXX

(XXXX Ral codu yazınız, Write Ral Code)

Renkler / Colors

Pres / Mill Finish

Beyaz / White

Metalik Gri / Metallic Grey

Antrasit Gri / Anthracite

Şampanya / Champagne

Bronz / Bronze

Kahverengi / Brown

Özel Ral Renkler / Special Ral Colors

55
mm

Alüminyum Çift Duvarlı 55 mm Lamel Deliksiz

Aluminium Double Wall 55 mm Slat, Non Perforated

Özellikler / Properties

Metre Ağırlığı Weight per Meter	0,385 kg/m
Metrekare Ağırlığı Weight per Square Meter	7.000 kg/m ²
Bir Metre Yükseklikteki Lamel Sayısı Number of Slats per one meter height	18 adet / pieces
Tavsiye Edilen Azami En Maximum Recommended Width	4.000 mm
Tavsiye Edilen Azami Yükseklik Maximum Recommended Height	3.000 mm
Standart Üretim Boyu Standart Manufacturing Length	6.500 mm
Paketteki Adet Pieces per Package	5 adet / pieces (32.5 m)

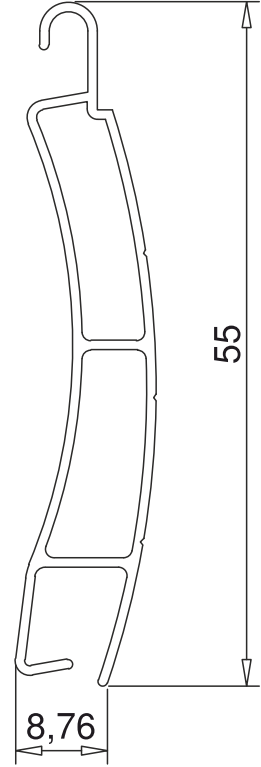

Kodlar / Codes

SAE.055.CZ.0000

SAE.055.CZ.9016

SAE.055.CZ.9006

SAE.055.CZ.7016

SAE.055.CZ.9500

SAE.055.CZ.9501

SAE.055.CZ.8014

SAE.055.CZ.XXXX

(XXXX Ral codu yazınız, Write Ral Code)

Renkler / Colors

Pres / Mill Finish

Beyaz / White

Metalik Gri / Metallic Grey

Antrasit Gri / Anthracite

Şampanya / Champagne

Bronz / Bronze

Kahverengi / Brown

Özel Ral Renkler / Special Ral Colors

62
mm

Alüminyum Çift Duvarlı 62 mm Lamel Deliksiz

Aluminium Double Wall 62 mm Slat, Non Perforated

Özellikler / Properties

Metre Ağırlığı Weight per Meter	0,470 kg/m
Metrekare Ağırlığı Weight per Square Meter	7,520 kg/m ²
Bir Metre Yükseklikteki Lamel Sayısı Number of Slats per one meter height	16 adet / pieces
Tavsiye Edilen Azami En Maximum Recommended Width	4.500 mm
Tavsiye Edilen Azami Yükseklik Maximum Recommended Height	3.000 mm
Standart Üretim Boyu Standart Manufacturing Length	6.500 mm
Paketteki Adet Pieces per Package	5 adet / pieces (32.5 m)

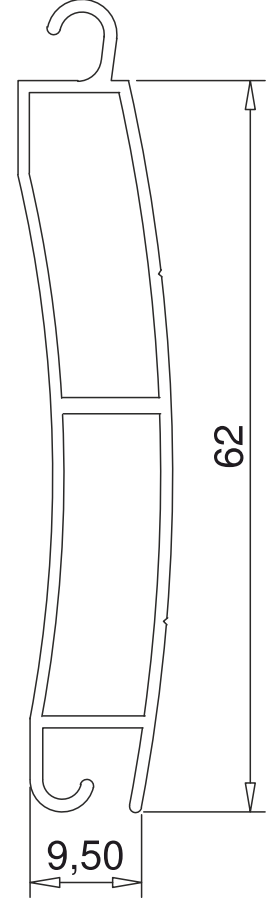

Kodlar / Codes

SAE.062.CZ.0000

SAE.062.CZ.9016

SAE.062.CZ.9006

SAE.062.CZ.7016

SAE.062.CZ.9500

SAE.062.CZ.9501

SAE.062.CZ.8014

SAE.062.CZ.XXXX

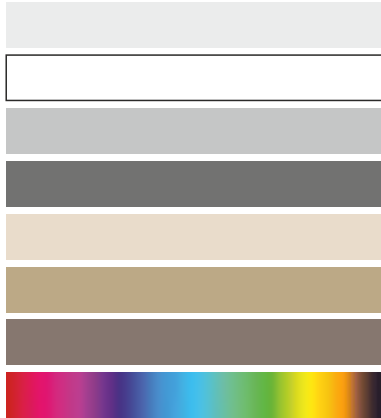

(XXXX Ral codu yazınız, Write Ral Code)

Renkler / Colors

Pres / Mill Finish

Beyaz / White

Metalik Gri / Metallic Grey

Antrasit Gri / Anthracite

Şampanya / Champagne

Bronz / Bronze

Kahverengi / Brown

Özel Ral Renkler / Special Ral Colors

62
mm

Alüminyum Tek Duvarlı 62 mm Lamel Deliksiz (Penceresiz)

Aluminium Single Wall 62 mm Slat, Non Perforated (Without Hole)

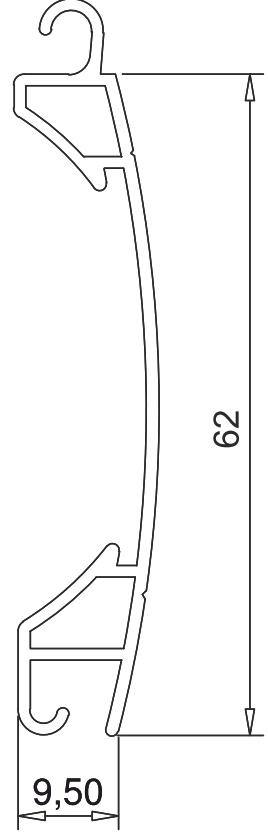

Özellikler / Properties

Metre Ağırlığı Weight per Meter	0,430 kg/m
Metrekare Ağırlığı Weight per Square Meter	6,880 kg/m ²
Bir Metre Yükseklikteki Lamel Sayısı Number of Slats per one meter height	16 adet / pieces
Tavsiye Edilen Azami En Maximum Recommended Width	4.500 mm
Tavsiye Edilen Azami Yükseklik Maximum Recommended Height	3.000 mm
Standart Üretim Boyu Standart Manufacturing Length	6.500 mm
Paketteki Adet Pieces per Package	5 adet / pieces (32.5 m)

Kodlar / Codes

SAE.062.TZ.0000

SAE.062.TZ.9016

SAE.062.TZ.9006

SAE.062.TZ.7016

SAE.062.TZ.9500

SAE.062.TZ.9501

SAE.062.TZ.8014

SAE.062.TZ.XXXX

(XXXX Ral codu yazınız, Write Ral Code)

Renkler / Colors

Pres / Mill Finish

Beyaz / White

Metalik Gri / Metallic Grey

Antrasit Gri / Anthracite

Şampanya / Champagne

Bronz / Bronze

Kahverengi / Brown

Özel Ral Renkler / Special Ral Colors

62
mm

Alüminyum Tek Duvarlı 62 mm Lamel Deliksiz (20 mm Pencere)

Aluminium Single Wall 62 mm Slat, Non Perforated (With 20 mm Hole)

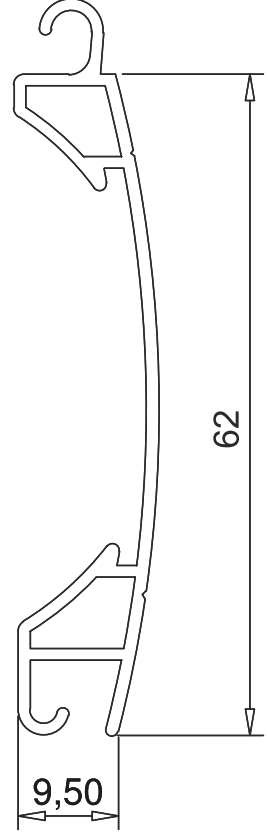

Özellikler / Properties

Metre Ağırlığı Weight per Meter	0,430 kg/m
Metrekare Ağırlığı Weight per Square Meter	6,880 kg/m ²
Bir Metre Yükseklikteki Lamel Sayısı Number of Slats per one meter height	16 adet / pieces
Tavsiye Edilen Azami En Maximum Recommended Width	4.500 mm
Tavsiye Edilen Azami Yükseklik Maximum Recommended Height	3.000 mm
Standart Üretim Boyu Standart Manufacturing Length	6.500 mm
Paketteki Adet Pieces per Package	5 adet / pieces (32.5 m)

Kodlar / Codes

SAE.062.TW.0000

SAE.062.TW.9016

SAE.062.TW.9006

SAE.062.TW.7016

SAE.062.TW.9500

SAE.062.TW.9501

SAE.062.TW.8014

SAE.062.TW.XXXX

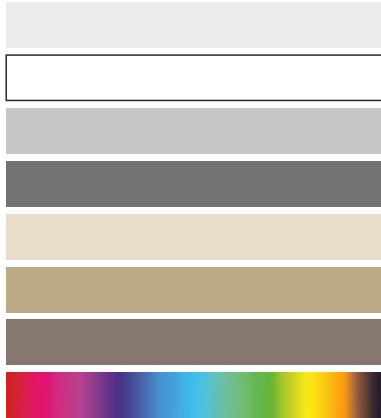

Renkler / Colors

Pres / Mill Finish

Beyaz / White

Metalik Gri / Metallic Grey

Antrasit Gri / Anthracite

Şampanya / Champagne

Bronz / Bronze

Kahverengi / Brown

Özel Ral Renkler / Special Ral Colors

(XXXX Ral codu yazınız, Write Ral Code)

77
mm

Alüminyum Çift Duvarlı 77 mm Lamel Deliksiz

Aluminium Double Wall 77 mm Slat, Non Perforated

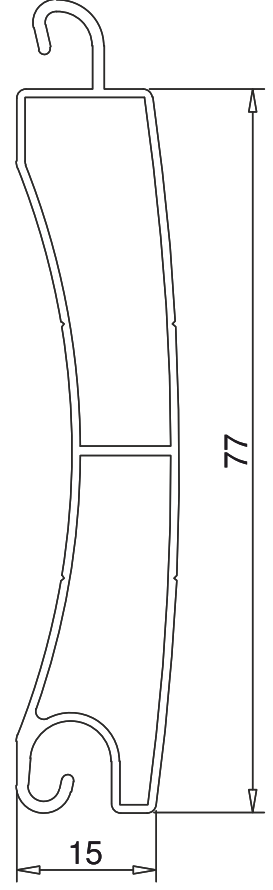

Özellikler / Properties

Metre Ağırlığı Weight per Meter	0.620 kg/m
Metrekare Ağırlığı Weight per Square Meter	8.040 kg/m ²
Bir Metre Yükseklikteki Lamel Sayısı Number of Slats per one meter height	13 adet / pieces
Tavsiye Edilen Azami En Maximum Recommended Width	5.500 mm
Tavsiye Edilen Azami Yükseklik Maximum Recommended Height	3.000 mm
Standart Üretim Boyu Standart Manufacturing Length	6.500 mm
Paketteki Adet Pieces per Package	5 adet / pieces (32.5 m)

Kodlar / Codes

SAE.077.CZ.0000

SAE.077.CZ.9016

SAE.077.CZ.9006

SAE.077.CZ.7016

SAE.077.CZ.9500

SAE.077.CZ.9501

SAE.077.CZ.8014

SAE.077.CZ.XXXX

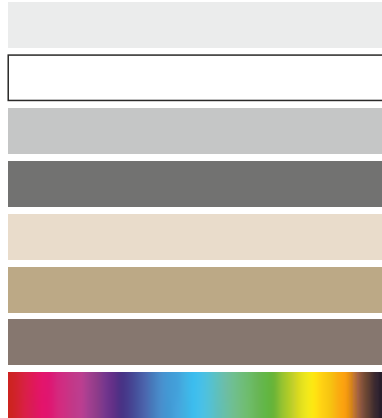

Renkler / Colors

Pres / Mill Finish

Beyaz / White

Metalik Gri / Metallic Grey

Antrasit Gri / Anthracite

Şampanya / Champagne

Bronz / Bronze

Kahverengi / Brown

Özel Ral Renkler / Special Ral Colors

(XXXX Ral codu yazınız, Write Ral Code)

77
mm

Alüminyum Tek Duvarlı 77 mm Lamel Deliksiz (47 mm Pencere)

Aluminium Single Wall 77 mm Slat, Non Perforated (With 47 mm Hole)

Özellikler / Properties

Metre Ağırlığı Weight per Meter	0,430 kg/m
Metrekare Ağırlığı Weight per Square Meter	6,880 kg/m ²
Bir Metre Yükseklikteki Lamel Sayısı Number of Slats per one meter height	16 adet / pieces
Tavsiye Edilen Azami En Maximum Recommended Width	4.500 mm
Tavsiye Edilen Azami Yükseklik Maximum Recommended Height	3.000 mm
Standart Üretim Boyu Standart Manufacturing Length	6.500 mm
Paketteki Adet Pieces per Package	5 adet / pieces (32.5 m)

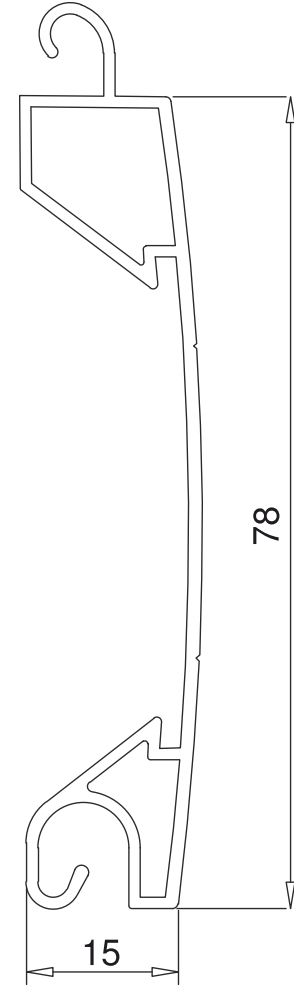

Kodlar / Codes

SAE.077.TW.0000

SAE.077.TW.9016

SAE.077.TW.9006

SAE.077.TW.7016

SAE.077.TW.9500

SAE.077.TW.9501

SAE.077.TW.8014

SAE.077.TW.XXXX

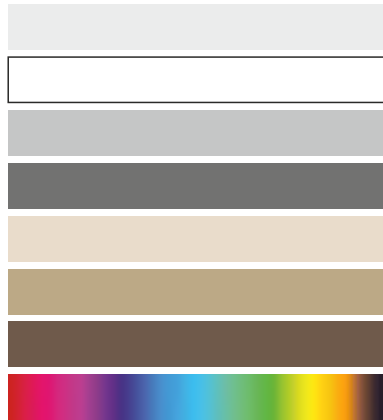

(XXXX Ral codu yazınız, Write Ral Code)

Renkler / Colors

Pres / Mill Finish

Beyaz / White

Metalik Gri / Metallic Grey

Antrasit Gri / Anthracite

Şampanya / Champagne

Bronz / Bronze

Kahverengi / Brown

Özel Ral Renkler / Special Ral Colors

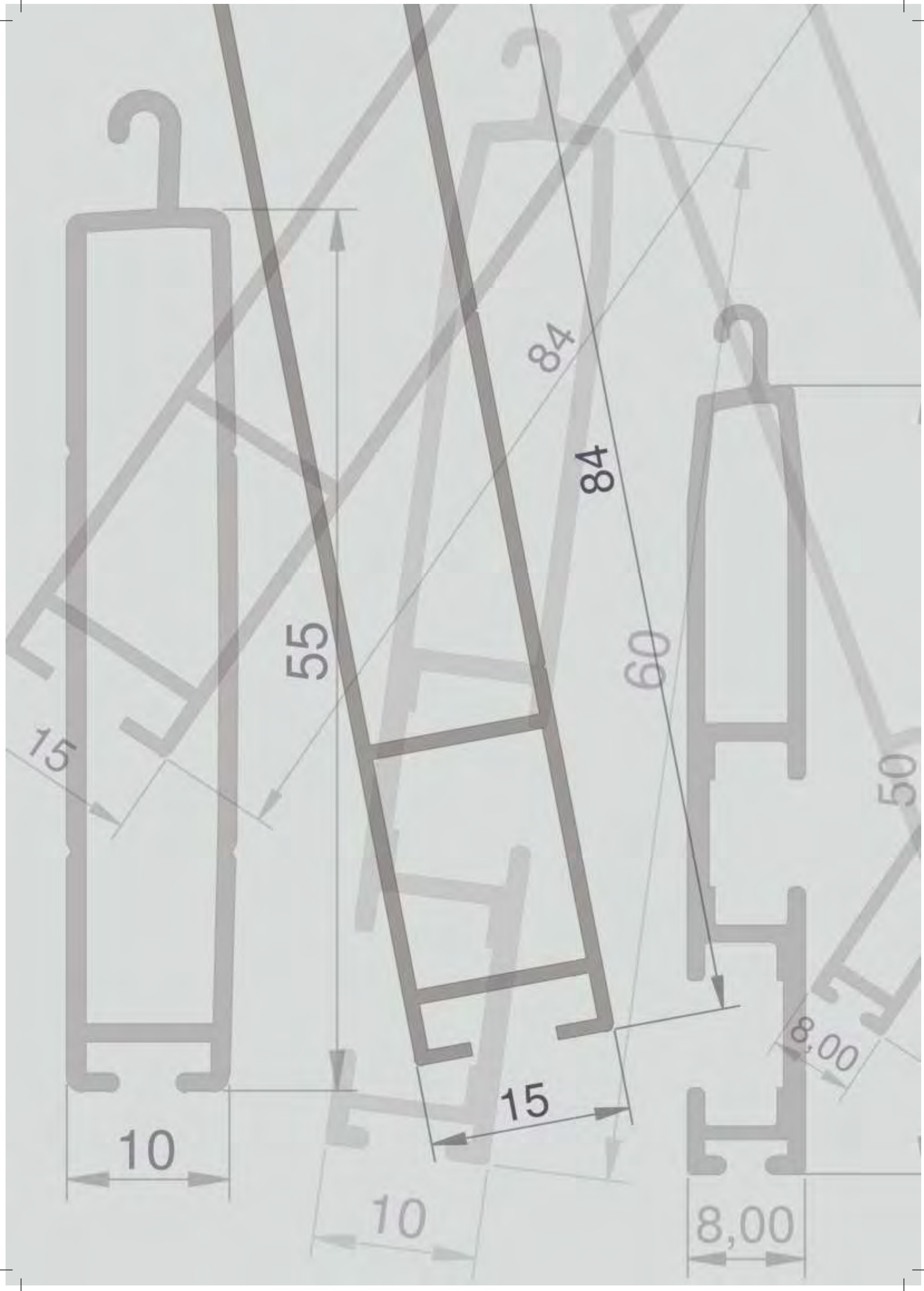

84

84

55

60

15

50

8,00

15

10

10

8,00

SARAY[®] | ROLL

ALT PARÇALAR
END SLATS

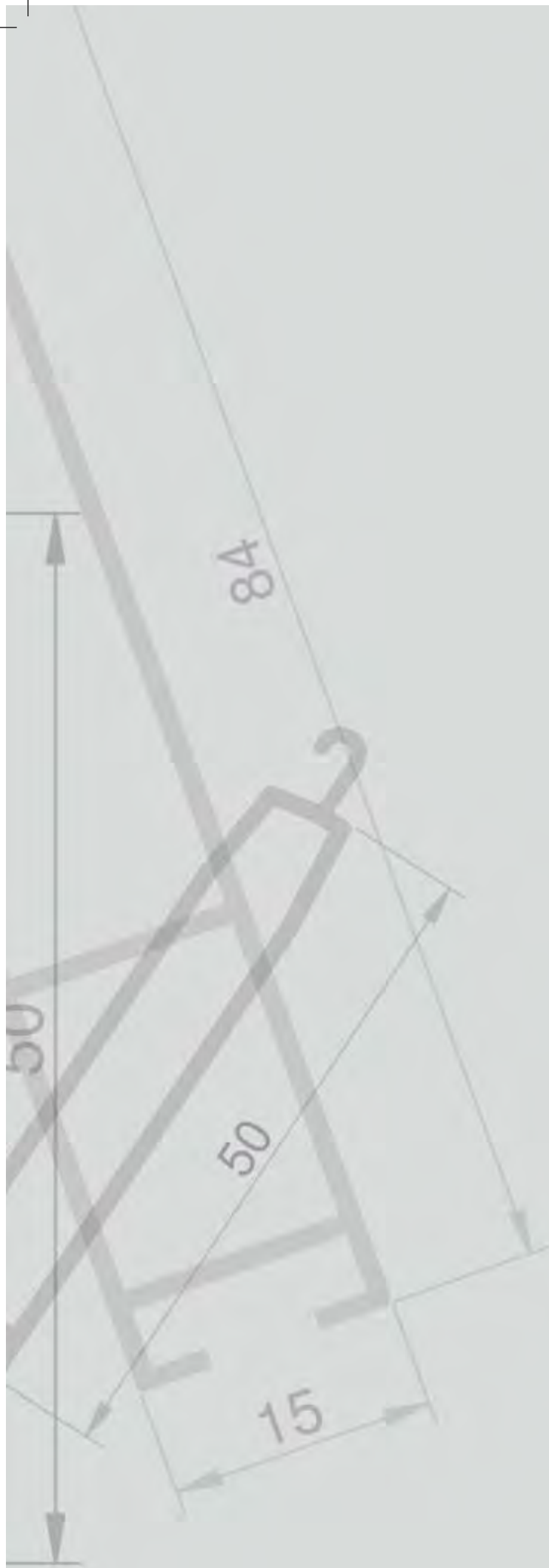

50 mm Alt Parça (39 mm Lameller İle Kullanılır)

50 mm Inside Outside Locked End Slat (Used With 39 mm Slats)

Özellikler / Properties

Metre Ağırlığı Weight per Meter	0,325 kg/m
Standart Üretim Boyu Standart Manufacturing Length	6.500 mm
Paketteki Adet Pieces per Package	5 adet / pieces (32.5 m)

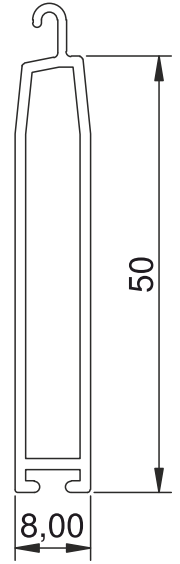

Kodlar / Codes

FAE.050.0S.0000

FAE.050.0S.9016

FAE.050.0S.9006

FAE.050.0S.7016

FAE.050.0S.9500

FAE.050.0S.9501

FAE.050.0S.8014

FAE.050.0S.XXXX

(XXXX Ral codu yazınız, Write Ral Code)

Renkler / Colors

Pres / Mill Finish

Beyaz / White

Metalik Gri / Metallic Grey

Antrasit Gri / Anthracite

Şampanya / Champagne

Bronz / Bronze

Kahvarengi / Brown

Özel Ral Renkler / Special Ral Colors

50 mm İç Dış Kilitli Alt Parça (39 mm Lameller ile Kullanılır)

50 mm Inside Outside Locked End Slat (Used With 39 mm Slats)

Özellikler / Properties

Metre Ağırlığı Weight per Meter	0,393 kg/m
Standart Üretim Boyu Standart Manufacturing Length	6.500 mm
Paketteki Adet Pieces per Package	5 adet / pieces (32.5 m)

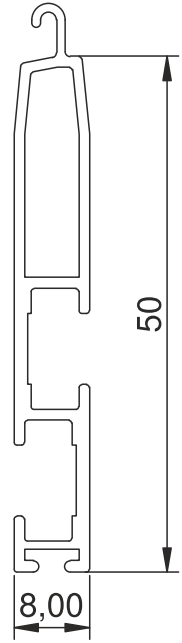

Kodlar / Codes

FAE.050.0K.0000

FAE.050.0K.9016

FAE.050.0K.9006

FAE.050.0K.7016

FAE.050.0K.9500

FAE.050.0K.9501

FAE.050.0K.8014

FAE.050.0K.XXXX

(XXXX Ral codu yazınız, Write Ral Code)

Renkler / Colors

Pres / Mill Finish

Beyaz / White

Metalik Gri / Metallic Grey

Antrasit Gri / Anthracite

Şampanya / Champagne

Bronz / Bronze

Kahvarengi / Brown

Özel Ral Renkler / Special Ral Colors

55 mm Alt Parça (55 mm Lameller İle Kullanılır)

55 mm End Slat (Used With 55 mm Slats)

Özellikler / Properties

Metre Ağırlığı Weight per Meter	0,420 kg/m
Standart Üretim Boyu Standart Manufacturing Length	6.500 mm
Paketteki Adet Pieces per Package	5 adet / pieces (32.5 m)

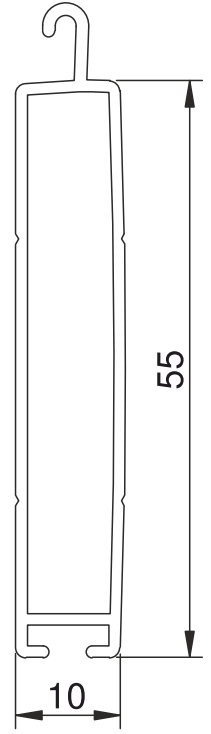

Kodlar / Codes

FAE.055.OS.0000

FAE.055.OS.9016

FAE.055.OS.9006

FAE.055.OS.7016

FAE.055.OS.9500

FAE.055.OS.9501

FAE.055.OS.8014

FAE.055.OS.XXXX

(XXXX Ral codu yazınız, Write Ral Code)

Renkler / Colors

Pres / Mill Finish

Beyaz / White

Metalik Gri / Metallic Grey

Antrasit Gri / Anthracite

Şampanya / Champagne

Bronz / Bronze

Kahvarengi / Brown

Özel Ral Renkler / Special Ral Colors

60 mm İç Dış Kilitlemeli Alt Parça (55 mm Lameller ile Kullanılır)

60 mm Inside Outside Locked End Slat (Used With 55 mm Slats)

Özellikler / Properties

Metre Ağırlığı Weight per Meter	0,475 kg/m
Standart Üretim Boyu Standart Manufacturing Length	6.500 mm
Paketteki Adet Pieces per Package	5 adet / pieces (32.5 m)

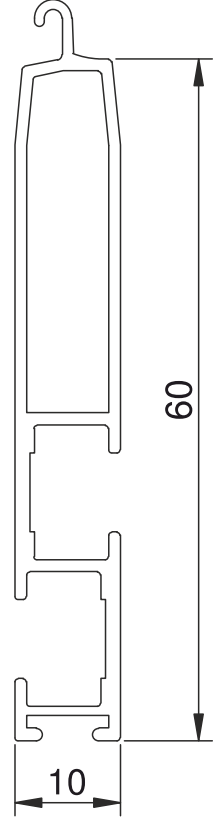

Kodlar / Codes

FAE.060.0K.0000

FAE.060.0K.9016

FAE.060.0K.9006

FAE.060.0K.7016

FAE.060.0K.9500

FAE.060.0K.9501

FAE.060.0K.8014

FAE.060.0K.XXXX

(XXXX Ral codu yazınız, Write Ral Code)

Renkler / Colors

Pres / Mill Finish

Beyaz / White

Metalik Gri / Metallic Grey

Antrasit Gri / Anthracite

Şampanya / Champagne

Bronz / Bronze

Kahvarengi / Brown

Özel Ral Renkler / Special Ral Colors

84 mm Alt Parça (77 mm Lameller İle Kullanılır.)

84 mm End Slat (Used With 77 mm Slats)

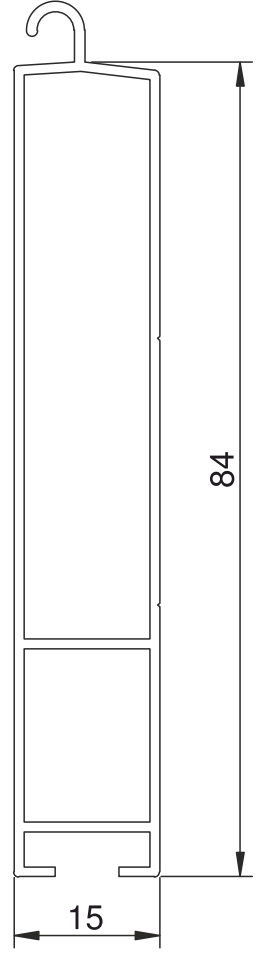

Özellikler / Properties

Metre Ağırlığı Weight per Meter	0,480 kg/m
Standart Üretim Boyu Standart Manufacturing Length	6.500 mm
Paketteki Adet Pieces per Package	5 adet / pieces (32.5 m)

Kodlar / Codes

FAE.084.0S.0000

FAE.084.0S.9016

FAE.084.0S.9006

FAE.084.0S.7016

FAE.084.0S.9500

FAE.084.0S.9501

FAE.084.0S.8014

FAE.084.0S.XXXX

(XXXX Ral codu yazınız, Write Ral Code)

Renkler / Colors

Pres / Mill Finish

Beyaz / White

Metalik Gri / Metallic Grey

Antrasit Gri / Anthracite

Şampanya / Champagne

Bronz / Bronze

Kahvarengi / Brown

Özel Ral Renkler / Special Ral Colors

AKILLI PANJURLAR
INTELLIGENT SHUTTERS



SARAY[®] | ROLL

DİKMELER
GUIDE RAILS

30 mm Kutusuz Yan Ray Profili (39 mm Lameller İçin Kullanılır)

30 mm Guide Rail Without Box For 39 mm Slats

Özellikler / Properties

Metre Ağırlığı Weight per Meter	0,330 kg/m
Standart Üretim Boyu Standart Manufacturing Length	6.500 mm
Paketteki Adet Pieces per Package	5 adet / pieces (32.5 m)

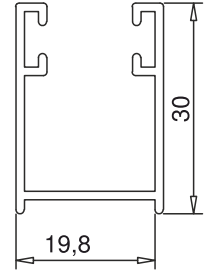

Kodlar / Codes

GAE.030.0U.0000

GAE.030.0U.9016

GAE.030.0U.9006

GAE.030.0U.7016

GAE.030.0U.9500

GAE.030.0U.9501

GAE.030.0U.8014

GAE.030.0U.XXXX

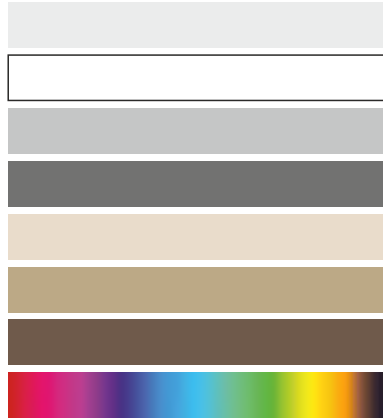

(XXXX Ral codu yazınız, Write Ral Code)

Renkler / Colors

Pres / Mill Finish

Beyaz / White

Metalik Gri / Metallic Grey

Antrasit Gri / Anthracite

Şampanya / Champagne

Bronz / Bronze

Kahverengi / Brown

Özel Ral Renkler / Special Ral Colors

53 mm Kutulu Yan Ray Profili (39 mm Lameller İçin Kullanılır)

53 mm Guide Rail Without Box For 39 mm Slats

Özellikler / Properties

Metre Ağırlığı Weight per Meter	0,537 kg/m
Standart Üretim Boyu Standart Manufacturing Length	6.500 mm
Paketteki Adet Pieces per Package	5 adet / pieces (32.5 m)

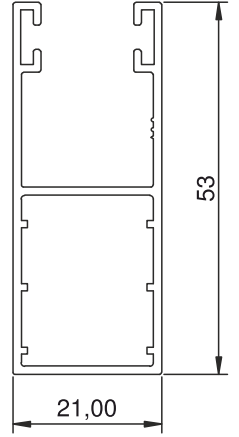

Kodlar / Codes

GAE.053.0B.0000
GAE.053.0B.9016
GAE.053.0B.9006
GAE.053.0B.7016
GAE.053.0B.9500
GAE.053.0B.9501
GAE.053.0B.8014
GAE.053.0B.XXXX

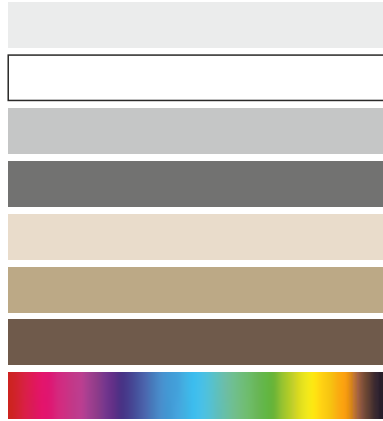

Renkler / Colors

Pres / Mill Finish
Beyaz / White
Metalik Gri / Metallic Grey
Antrasit Gri / Anthracite
Şampanya / Champagne
Bronz / Bronze
Kahverengi / Brown
Özel Ral Renkler / Special Ral Colors

(XXXX Ral codu yazınız, Write Ral Code)

65 mm Köşeli Yan Ray Profili (39 mm Lameller İçin Kullanılır)

65 mm Guide Rail Profile With Corner For 39 mm Slats

Özellikler / Properties

Metre Ağırlığı Weight per Meter	0,680 kg/m
Standart Üretim Boyu Standart Manufacturing Length	6.500 mm
Paketteki Adet Pieces per Package	5 adet / pieces (32.5 m)

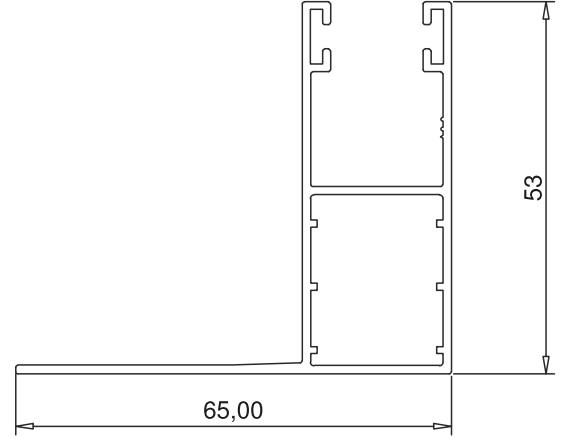

Kodlar / Codes

GAE.065.0L.0000

GAE.065.0L.9016

GAE.065.0L.9006

GAE.065.0L.7016

GAE.065.0L.9500

GAE.065.0L.9501

GAE.065.0L.8014

GAE.065.0L.XXXX

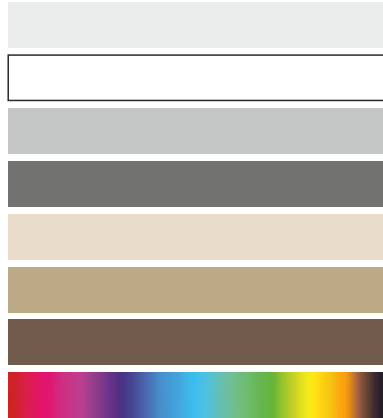

Renkler / Colors

Pres / Mill Finish

Beyaz / White

Metalik Gri / Metallic Grey

Antrasit Gri / Anthracite

Şampanya / Champagne

Bronz / Bronze

Kahverengi / Brown

Özel Ral Renkler / Special Ral Colors

(XXXX Ral codu yazınız, Write Ral Code)

79 mm Çift Kanallı Yan Ray Profili (39 mm Lameller İçin Kullanılır)

79 mm Double Channel Guide Rail Profile For 39 mm Slats

Özellikler / Properties

Metre Ağırlığı Weight per Meter	0,840 kg/m
Standart Üretim Boyu Standart Manufacturing Length	6.500 mm
Paketteki Adet Pieces per Package	5 adet / pieces (32.5 m)

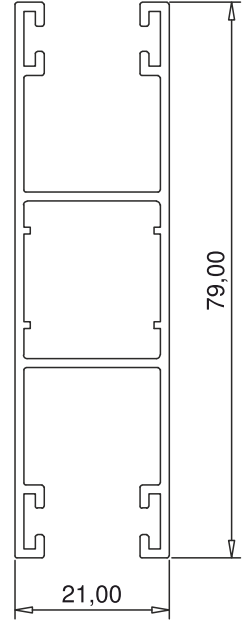

Kodlar / Codes

GAE.079.DU.0000

GAE.079.DU.9016

GAE.079.DU.9006

GAE.079.DU.7016

GAE.079.DU.9500

GAE.079.DU.9501

GAE.079.DU.8014

GAE.079.DU.XXXX

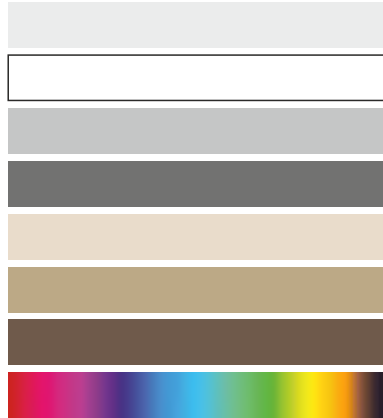

Renkler / Colors

Pres / Mill Finish

Beyaz / White

Metalik Gri / Metallic Grey

Antrasit Gri / Anthracite

Şampanya / Champagne

Bronz / Bronze

Kahverengi / Brown

Özel Ral Renkler / Special Ral Colors

(XXXX Ral codu yazınız, Write Ral Code)

40 mm Kutusuz Yan Ray Profili (55-60 mm Lameller İçin Kullanılır)

40 mm Guide Rail Without Box For 55-60 mm Slats

Özellikler / Properties

Metre Ağırlığı Weight per Meter	0,405 kg/m
Standart Üretim Boyu Standart Manufacturing Length	6.500 mm
Paketteki Adet Pieces per Package	5 adet / pieces (32.5 m)

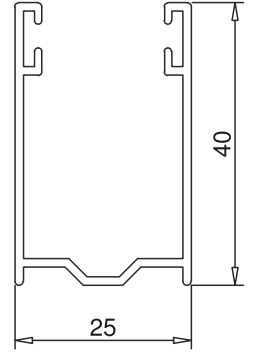

Kodlar / Codes

GAE.040.0U.0000

GAE.040.0U.9016

GAE.040.0U.9006

GAE.040.0U.7016

GAE.040.0U.9500

GAE.040.0U.9501

GAE.040.0U.8014

GAE.040.0U.XXXX

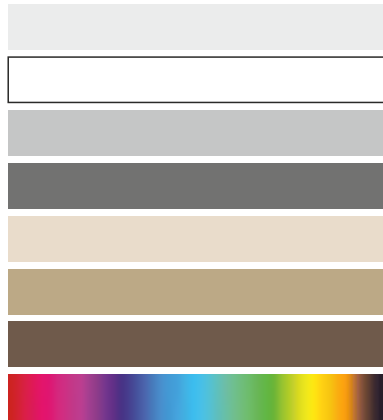

Renkler / Colors

Pres / Mill Finish

Beyaz / White

Metalik Gri / Metallic Grey

Antrasit Gri / Anthracite

Şampanya / Champagne

Bronz / Bronze

Kahverengi / Brown

Özel Ral Renkler / Special Ral Colors

(XXXX Ral codu yazınız, Write Ral Code)

69 mm Kutulu Yan Ray Profili 55-60 mm Lameller İçin Kullanılır

69 mm Guide Rail With Box Profile For 55-60 mm Slats

Özellikler / Properties

Metre Ağırlığı Weight per Meter	0,660 kg/m
Standart Üretim Boyu Standart Manufacturing Length	6.500 mm
Paketteki Adet Pieces per Package	5 adet / pieces (32.5 m)

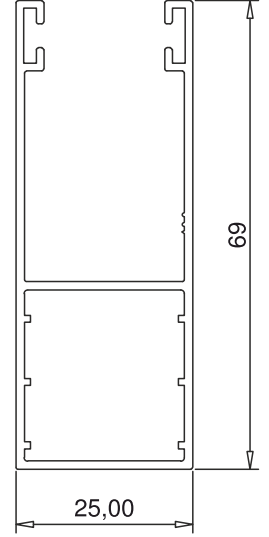

Kodlar / Codes

GAE.069.0B.0000

GAE.069.0B.9016

GAE.069.0B.9006

GAE.069.0B.7016

GAE.069.0B.9500

GAE.069.0B.9501

GAE.069.0B.8014

GAE.069.0B.XXXX

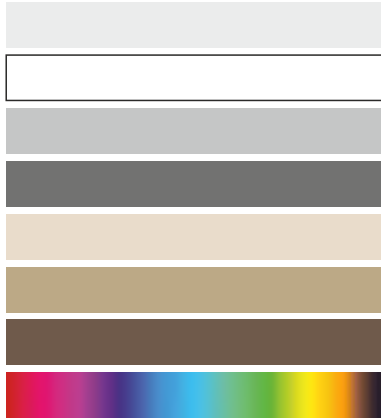

(XXXX Ral codu yazınız, Write Ral Code)

Renkler / Colors

Pres / Mill Finish

Beyaz / White

Metalik Gri / Metallic Grey

Antrasit Gri / Anthracite

Şampanya / Champagne

Bronz / Bronze

Kahverengi / Brown

Özel Ral Renkler / Special Ral Colors

106 mm Çift Kanallı Yan Ray Profili (55 mm Lameller İçin Kullanılır)

106 mm Double Channel Guide Rail Profile For 55 mm Slats

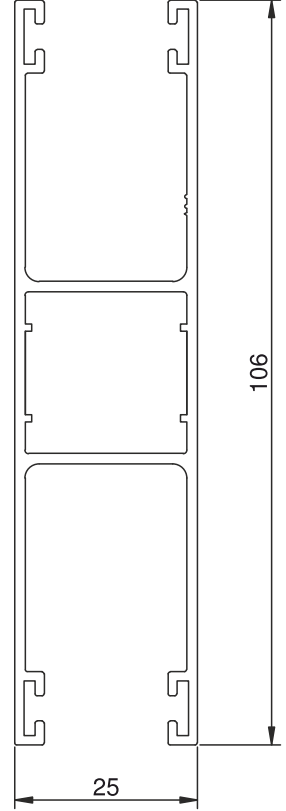

Özellikler / Properties

Metre Ağırlığı Weight per Meter	1,187 kg/m
Standart Üretim Boyu Standart Manufacturing Length	6.500 mm
Paketteki Adet Pieces per Package	5 adet / pieces (32.5 m)

Kodlar / Codes

GAE.106.DU.0000

GAE.106.DU.9016

GAE.106.DU.9006

GAE.106.DU.7016

GAE.106.DU.9500

GAE.106.DU.9501

GAE.106.DU.8014

GAE.106.DU.XXXX

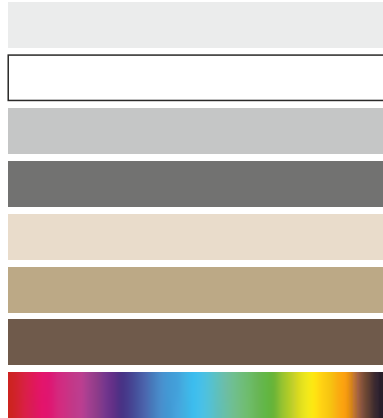

Renkler / Colors

Pres / Mill Finish

Beyaz / White

Metalik Gri / Metallic Grey

Antrasit Gri / Anthracite

Şampanya / Champagne

Bronz / Bronze

Kahverengi / Brown

Özel Ral Renkler / Special Ral Colors

(XXXX Ral codu yazınız, Write Ral Code)

90 mm Kutulu Yan Ray Profili (77 mm Lameller İçin Kullanılır)

90 mm Guide Rail With Box Profile For 77 mm Slats

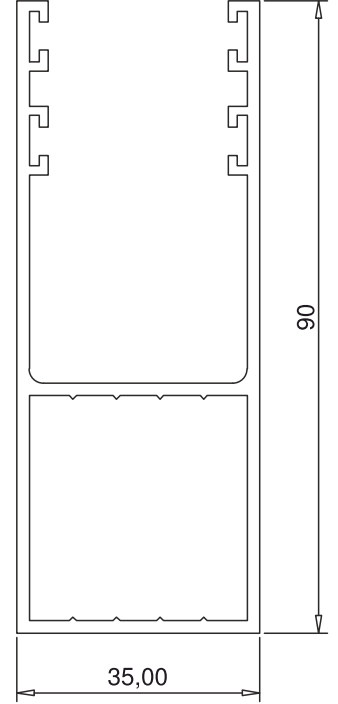

Özellikler / Properties

Metre Ağırlığı Weight per Meter	1,313 kg/m
Standart Üretim Boyu Standart Manufacturing Length	6.500 mm
Paketteki Adet Pieces per Package	5 adet / pieces (32.5 m)

Kodlar / Codes

GAE.090.0B.0000



GAE.090.0B.9016



GAE.090.0B.9006



GAE.090.0B.7016



GAE.090.0B.9500



GAE.090.0B.9501



GAE.090.0B.8014



GAE.090.0B.XXXX



Renkler / Colors

Pres / Mill Finish

Beyaz / White

Metalik Gri / Metallic Grey

Antrasit Gri / Anthracite

Şampanya / Champagne

Bronz / Bronze

Kahverengi / Brown

Özel Ral Renkler / Special Ral Colors

(XXXX Ral codu yazınız, Write Ral Code)



SARAY[®] | ROLL

BORULAR
TUBES



40 mm, 60 mm, 70 mm Sekizgen Boru

40 mm, 60 mm, 70 mm Octagonal Tube

**Özellikler / Properties**

Ürün Kodu Product Code	Kalınlık mm Thickness mm	Üretim Boyu mm Manufacturing Length mm	Paketteki Adet Pieces Per Package
TSS.040.00.0050	0.50	6000 mm	12 adet / pieces (72 m)
TSS.060.00.0060	0.60	6000 mm	6 adet / pieces (36 m)
TSS.060.00.0080	0.80	6000 mm	6 adet / pieces (36 m)
TSS.070.00.0100	1.00	6000 mm	3 adet / pieces (18 m)
TSS.070.00.0120	1.20	6000 mm	3 adet / pieces (18 m)

AKILLI PANJURLAR
INTELLIGENT SHUTTERS

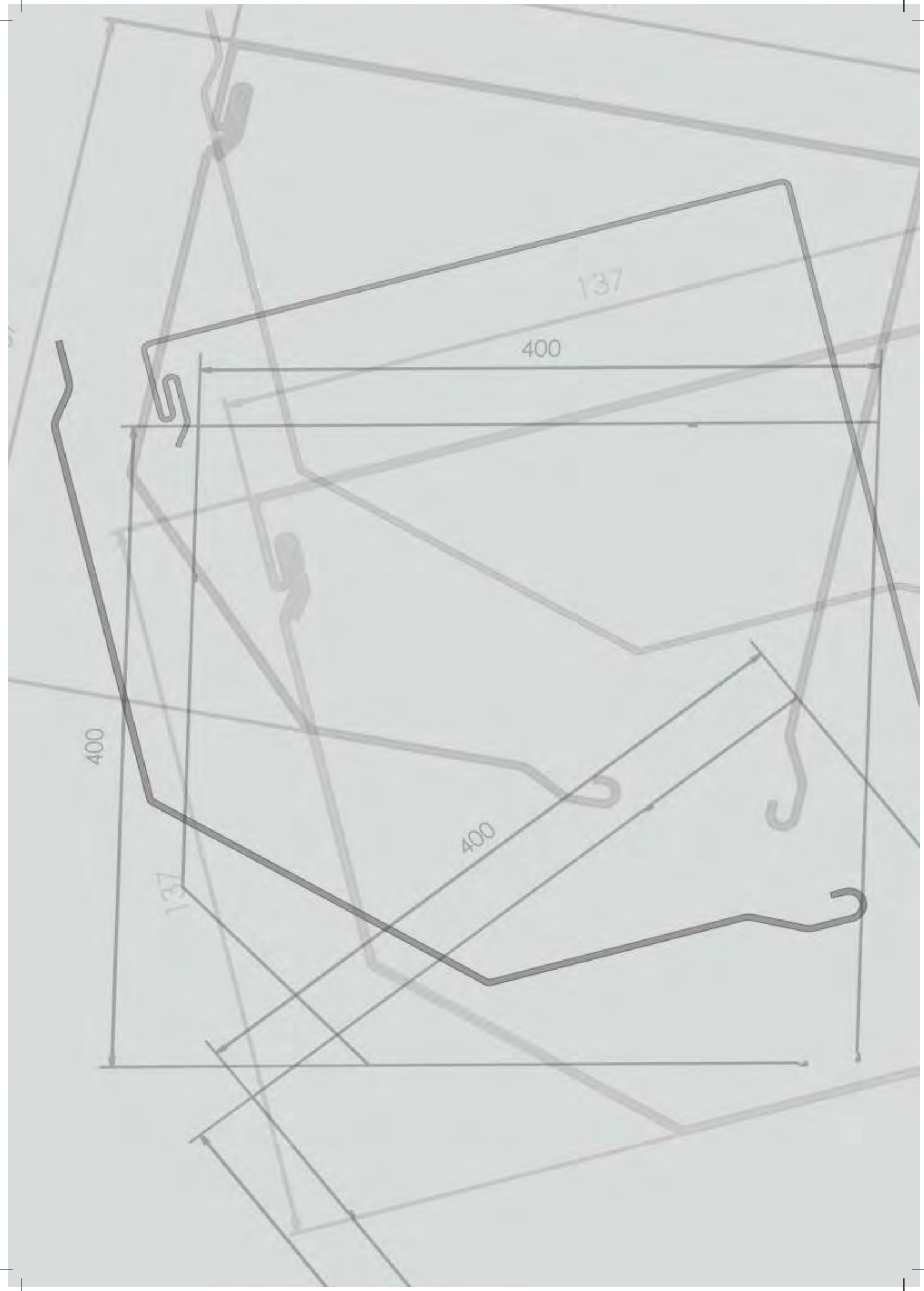

SARAY[®] | ROLL

ALÜMİNYUM KUTULAR
ALUMINIUM BOXES



137 mm Alüminyum Kutu 45 Derece

137 mm Aluminium Box 45 Degree

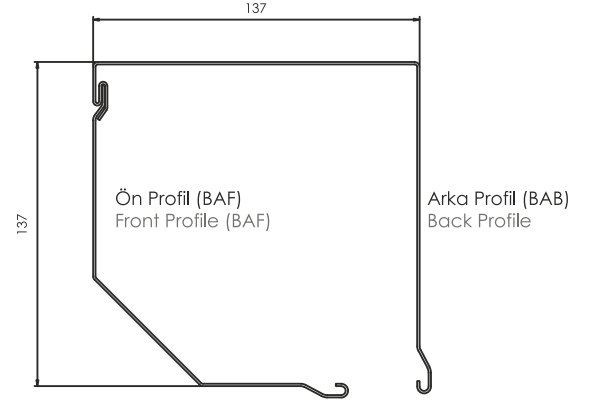

Özellikler / Properties

Standart Üretim Boyu Standart Manufacturing Length	6.000 mm
Paketteki Adet Pieces per Package	1 adet / pieces (6 m)

Ön Profil / Front Profile

Kodlar / Codes

BAF.137.01.9016



BAF.137.01.8014



BAF.137.01.0001



BAF.137.01.XXXX



(XXXX Ral codu yazınız, Write Ral Code)

Renkler / Colors

Beyaz / White

Kahverengi / Brown

Altın Meşe / Golden Oak

Özel Ral Renkler / Special Ral Colors

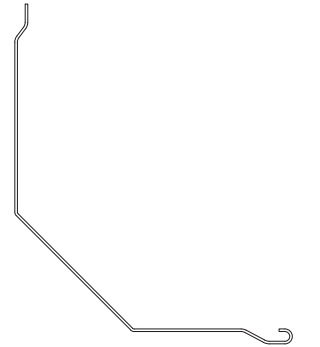

Arka Profil / Back Profile

Kodlar / Codes

BAB.137.01.9016



BAB.137.01.8014



BAB.137.01.0001



BAB.137.01.XXXX



(XXXX Ral codu yazınız, Write Ral Code)

Renkler / Colors

Beyaz / White

Kahverengi / Brown

Altın Meşe / Golden Oak

Özel Ral Renkler / Special Ral Colors

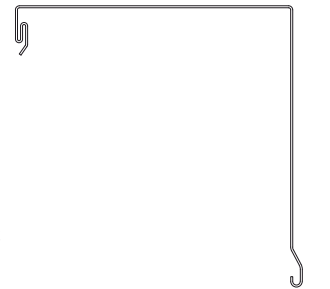

165 mm Alüminyum Kutu 45 Derece

165 mm Aluminium Box 45 Degree

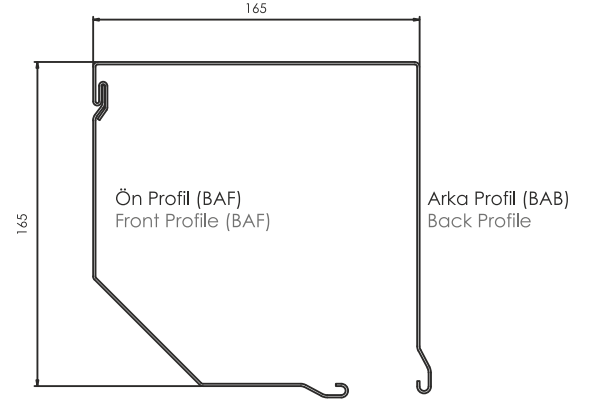

Özellikler / Properties

Standart Üretim Boyu Standart Manufacturing Length	6.000 mm
Paketteki Adet Pieces per Package	1 adet / pieces (6 m)

Ön Profil / Front Profile

Kodlar / Codes

BAF.165.01.9016



BAF.165.01.8014



BAF.165.01.0001



BAF.165.01.XXXX



(XXXX Ral codu yazınız, Write Ral Code)

Renkler / Colors

Beyaz / White

Kahverengi / Brown

Altın Meşe / Golden Oak

Özel Ral Renkler / Special Ral Colors

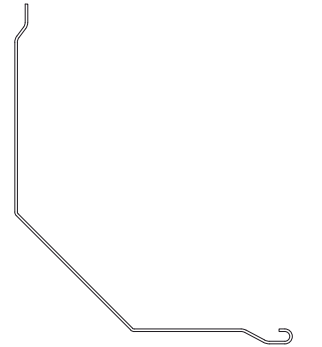

Arka Profil / Back Profile

Kodlar / Codes

BAB.165.01.9016



BAB.165.01.8014



BAB.165.01.0001



BAB.165.01.XXXX



(XXXX Ral codu yazınız, Write Ral Code)

Renkler / Colors

Beyaz / White

Kahverengi / Brown

Altın Meşe / Golden Oak

Özel Ral Renkler / Special Ral Colors

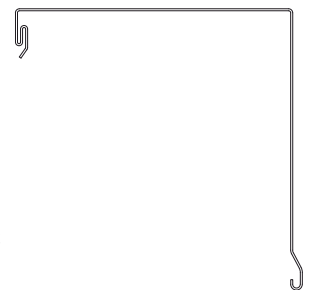

180 mm Alüminyum Kutu 45 Derece

180 mm Aluminium Box 45 Degree

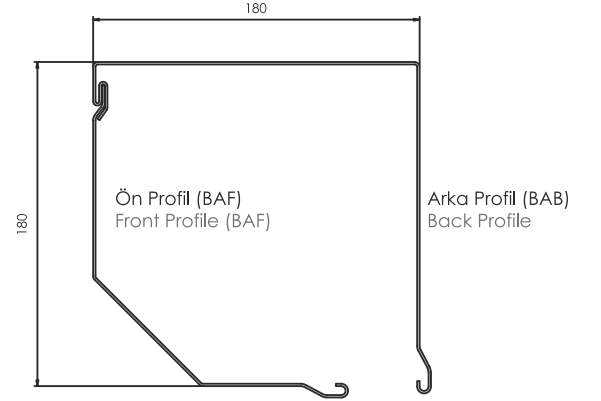

Özellikler / Properties

Standart Üretim Boyu Standart Manufacturing Length	6.000 mm
Paketteki Adet Pieces per Package	1 adet / pieces (6 m)

Ön Profil / Front Profile

Kodlar / Codes

BAF.180.01.9016



BAF.180.01.8014



BAF.180.01.0001



BAF.180.01.XXXX



(XXXX Ral codu yazınız, Write Ral Code)

Renkler / Colors

Beyaz / White

Kahverengi / Brown

Altın Meşe / Golden Oak

Özel Ral Renkler / Special Ral Colors

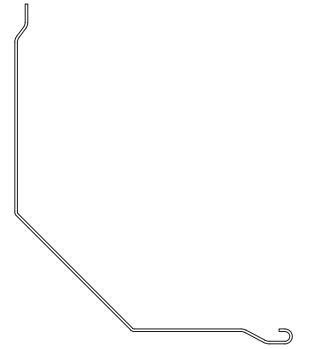

Arka Profil / Back Profile

Kodlar / Codes

BAB.180.01.9016



BAB.180.01.8014



BAB.180.01.0001



BAB.180.01.XXXX



(XXXX Ral codu yazınız, Write Ral Code)

Renkler / Colors

Beyaz / White

Kahverengi / Brown

Altın Meşe / Golden Oak

Özel Ral Renkler / Special Ral Colors

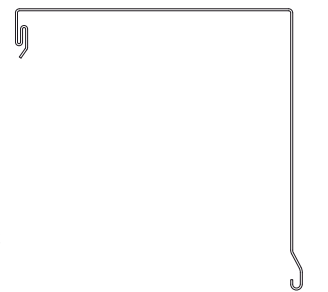

205 mm Alüminyum Kutu 45 Derece

205 mm Aluminium Box 45 Degree

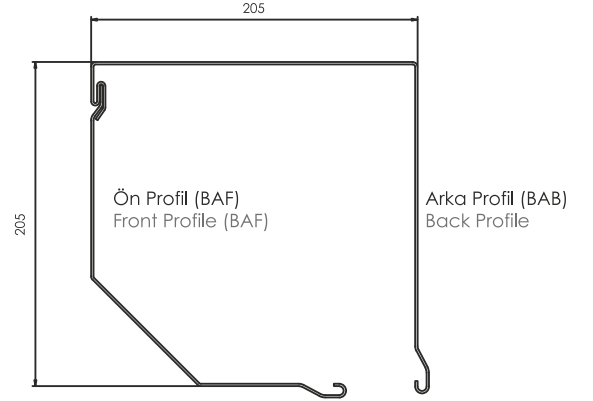

Özellikler / Properties

Standart Üretim Boyu Standart Manufacturing Length	6.000 mm
Paketteki Adet Pieces per Package	1 adet / pieces (6 m)

Ön Profil / Front Profile

Kodlar / Codes

BAF.205.01.9016



BAF.205.01.8014



BAF.205.01.0001



BAF.205.01.XXXX



(XXXX Ral codu yazınız, Write Ral Code)

Renkler / Colors

Beyaz / White

Kahverengi / Brown

Altın Meşe / Golden Oak

Özel Ral Renkler / Special Ral Colors

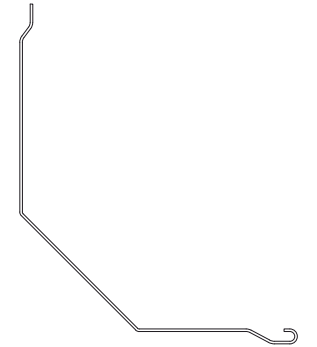

Arka Profil / Back Profile

Kodlar / Codes

BAB.205.01.9016



BAB.205.01.8014



BAB.205.01.0001



BAB.205.01.XXXX



(XXXX Ral codu yazınız, Write Ral Code)

Renkler / Colors

Beyaz / White

Kahverengi / Brown

Altın Meşe / Golden Oak

Özel Ral Renkler / Special Ral Colors

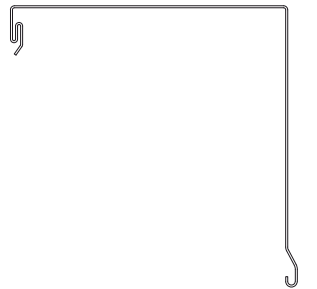

250 mm Alüminyum Kutu 45 Derece

250 mm Aluminium Box 45 Degree

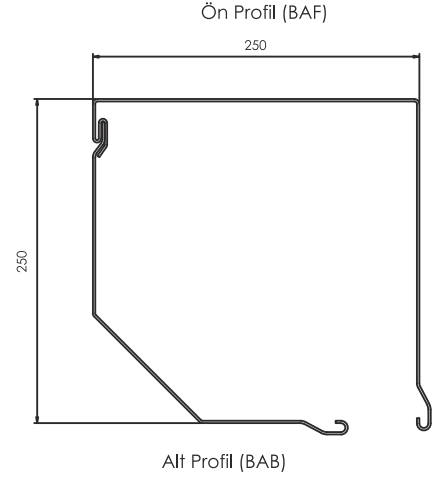

Özellikler / Properties

Standart Üretim Boyu Standart Manufacturing Length	6.000 mm
Paketteki Adet Pieces per Package	1 adet / pieces (6 m)

Ön Profil / Front Profile

Kodlar / Codes

BAF.250.01.9016



BAF.250.01.8014



BAF.250.01.0001



BAF.250.01.XXXX



(XXXX Ral codu yazınız, Write Ral Code)

Renkler / Colors

Beyaz / White

Kahverengi / Brown

Altın Meşe / Golden Oak

Özel Ral Renkler / Special Ral Colors

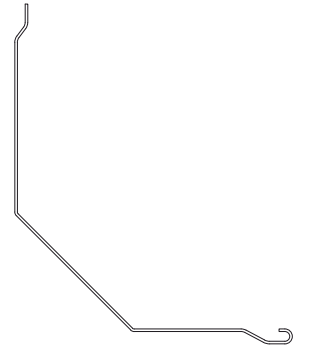

Arka Profil / Back Profile

Kodlar / Codes

BAB.250.01.9016



BAB.250.01.8014



BAB.250.01.0001



BAB.250.01.XXXX



(XXXX Ral codu yazınız, Write Ral Code)

Renkler / Colors

Beyaz / White

Kahverengi / Brown

Altın Meşe / Golden Oak

Özel Ral Renkler / Special Ral Colors

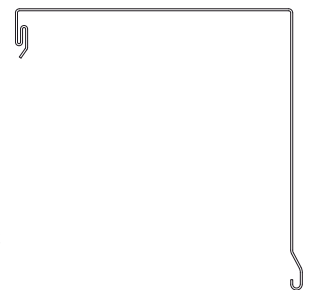

300 Mm Alüminyum Kutu 45 Derece

300 mm Aluminium Box 45 Degree

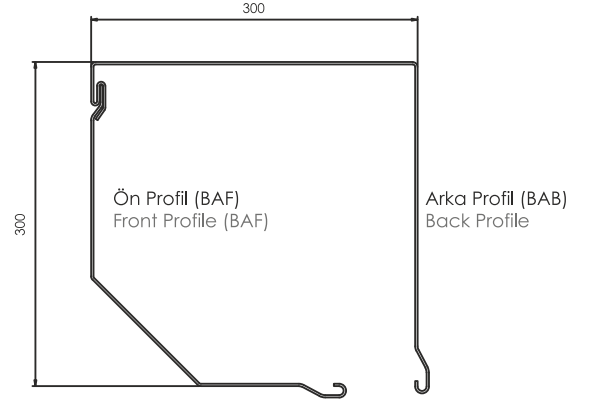

Özellikler / Properties

Standart Üretim Boyu Standart Manufacturing Length	6.000 mm
Paketteki Adet Pieces per Package	1 adet / pieces (6 m)

Ön Profil / Front Profile

Kodlar / Codes

BAF.300.01.9016



BAF.300.01.8014



BAF.300.01.0001



BAF.300.01.XXXX



(XXXX Ral codu yazınız, Write Ral Code)

Renkler / Colors

Beyaz / White

Kahverengi / Brown

Altın Meşe / Golden Oak

Özel Ral Renkler / Special Ral Colors

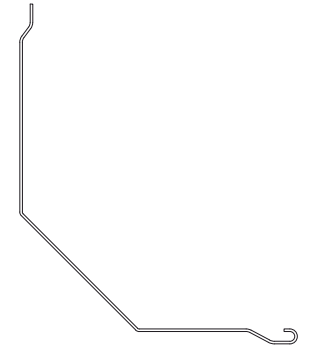

Arka Profil / Back Profile

Kodlar / Codes

BAB.300.01.9016



BAB.300.01.8014



BAB.300.01.0001



BAB.300.01.XXXX



(XXXX Ral codu yazınız, Write Ral Code)

Renkler / Colors

Beyaz / White

Kahverengi / Brown

Altın Meşe / Golden Oak

Özel Ral Renkler / Special Ral Colors

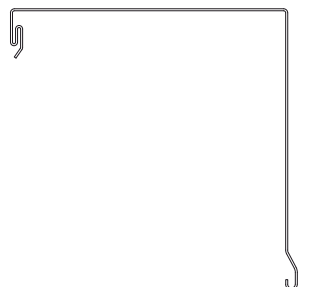

350 mm Alüminyum Kutu 45 Derece

350 mm Aluminium Box 45 Degree

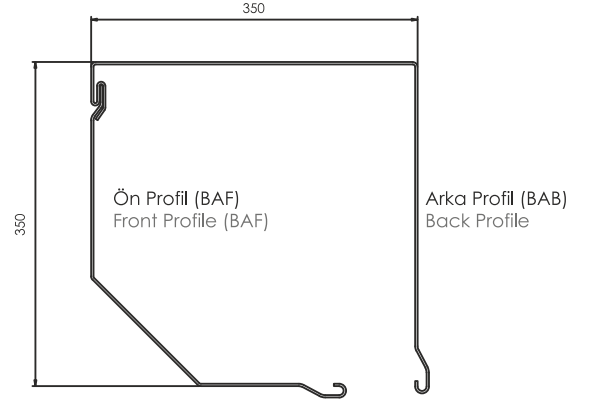

Özellikler / Properties

Standart Üretim Boyu Standart Manufacturing Length	6.000 mm
Paketteki Adet Pieces per Package	1 adet / pieces (6 m)

Ön Profil / Front Profile

Kodlar / Codes

BAF.350.01.9016



BAF.350.01.8014



BAF.350.01.0001



BAF.350.01.XXXX



(XXXX Ral codu yazınız, Write Ral Code)

Renkler / Colors

Beyaz / White

Kahverengi / Brown

Altın Meşe / Golden Oak

Özel Ral Renkler / Special Ral Colors

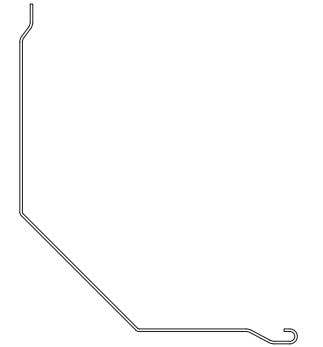

Arka Profil / Back Profile

Kodlar / Codes

BAB.350.01.9016



BAB.350.01.8014



BAB.350.01.0001



BAB.350.01.XXXX



(XXXX Ral codu yazınız, Write Ral Code)

Renkler / Colors

Beyaz / White

Kahverengi / Brown

Altın Meşe / Golden Oak

Özel Ral Renkler / Special Ral Colors

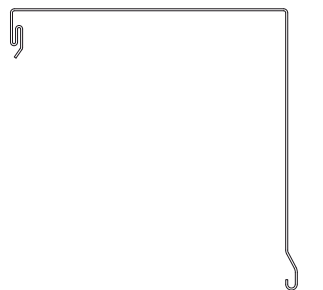

400 mm Alüminyum Kutu 45 Derece

400 mm Aluminium Box 45 Degree

Özellikler / Properties

Standart Üretim Boyu Standart Manufacturing Length	6.000 mm
Paketteki Adet Pieces per Package	1 adet / pieces (6 m)

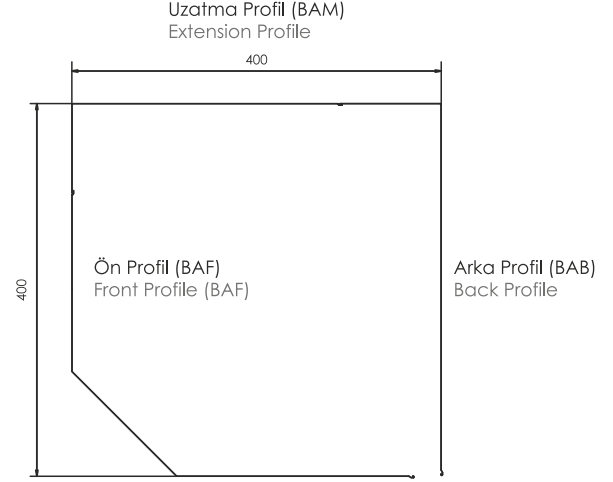

Ön Profil / Front Profile

Kodlar / Codes

BAF.400.01.9016



BAF.400.01.8014



BAF.400.01.0001



BAF.350.01.XXXX



(XXXX Ral codu yazınız, Write Ral Code)

Renkler / Colors

Beyaz / White

Kahverengi / Brown

Altın Meşe / Golden Oak

Özel Ral Renkler / Special Ral Colors

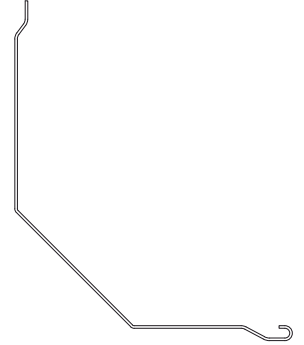

Uzatma Profili / Extension Profile

Kodlar / Codes

BAM.400.01.9016



BAM.400.01.8014



BAM.400.01.0001



BAM.400.01.XXXX



(XXXX Ral codu yazınız, Write Ral Code)

Renkler / Colors

Beyaz / White

Kahverengi / Brown

Altın Meşe / Golden Oak

Özel Ral Renkler / Special Ral Colors



Arka Profil / Back Profile

Kodlar / Codes

BAB.400.01.9016



BAB.400.01.8014



BAB.400.01.0001



BAB.400.01.XXXX



(XXXX Ral codu yazınız, Write Ral Code)

Renkler / Colors

Beyaz / White

Kahverengi / Brown

Altın Meşe / Golden Oak

Özel Ral Renkler / Special Ral Colors



SARAY® ROLL

SAE.105.01.....

R

	1	2	3	4	5	6	7	8	9	10	11	12
17	○	○	○	○	○	○	○	○	○	○	○	○
18	○	○	○	○	○	○	○	○	○	○	○	○
19	○	○	○	○	○	○	○	○	○	○	○	○
20	○	○	○	○	○	○	○	○	○	○	○	○
21	○	○	○	○	○	○	○	○	○	○	○	○
22	○	○	○	○	○	○	○	○	○	○	○	○
23	○	○	○	○	○	○	○	○	○	○	○	○
24	○	○	○	○	○	○	○	○	○	○	○	○
25	○	○	○	○	○	○	○	○	○	○	○	○
26	○	○	○	○	○	○	○	○	○	○	○	○

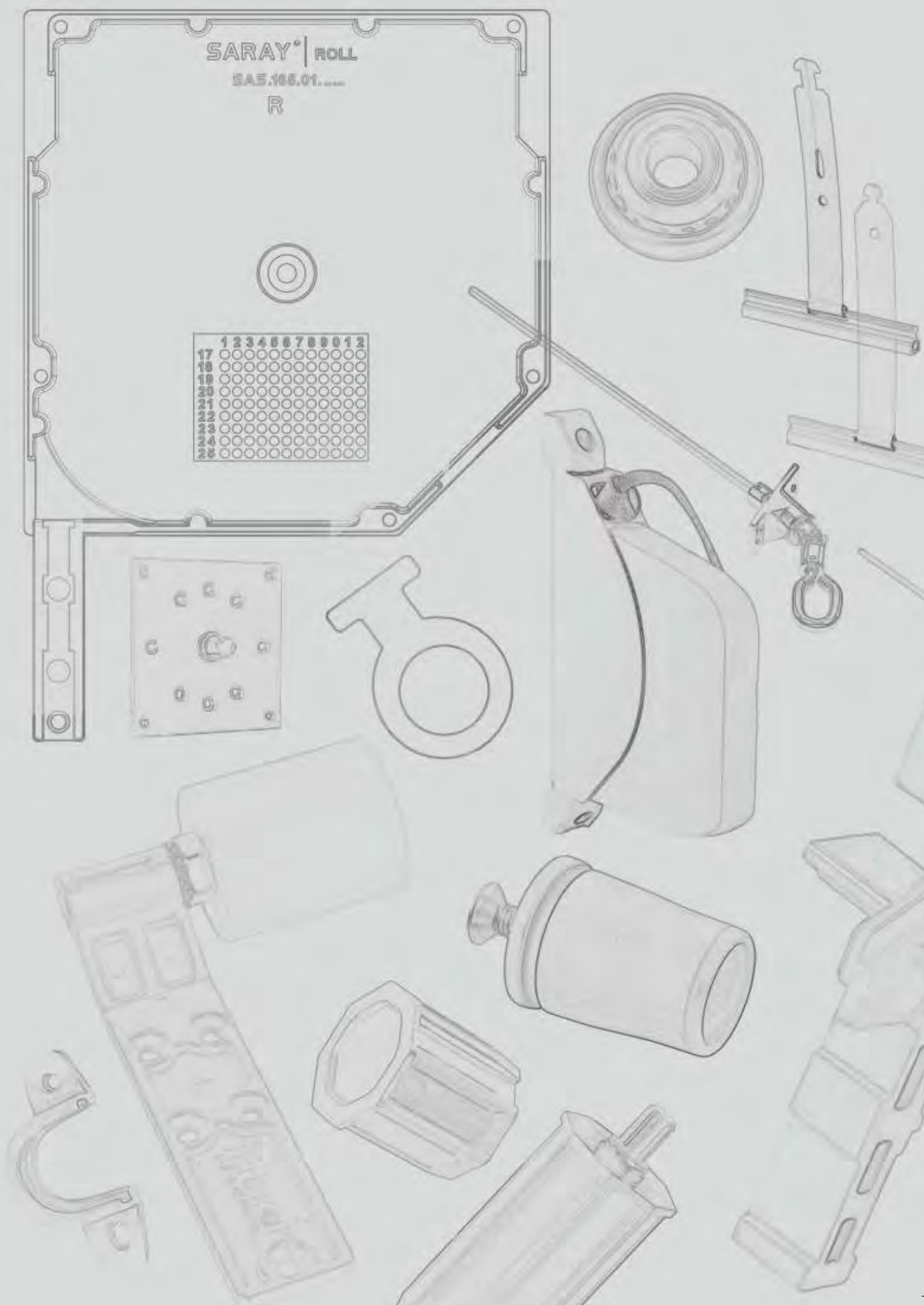

SARAY[®] | ROLL

AKSESUARLAR
ACCESSORIES



137 mm Alüminyum Yan Kapak

137 mm Aluminium Side Frames

Kodlar / Codes

SAS.137.01.0000

SAS.137.01.9016

SAS.137.01.8014

SAS.137.01.XXXX

(XXXX Ral codu yazınız, Write Ral Code)

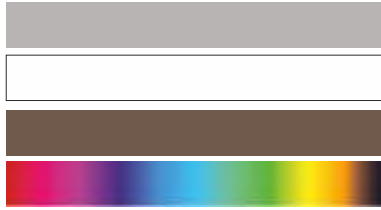

Renkler / Colors

Pres / Pres

Beyaz / White

Kahverengi / Brown

Özel Ral Renkler / Special Ral Colors

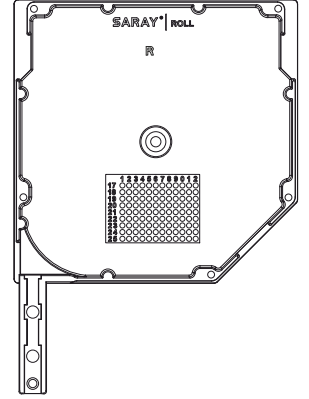

165 mm Alüminyum Yan Kapak

165 mm Aluminium Side Frames

Kodlar / Codes

SAS.165.01.0000

SAS.165.01.9016

SAS.165.01.8014

SAS.165.01.XXXX

(XXXX Ral codu yazınız, Write Ral Code)

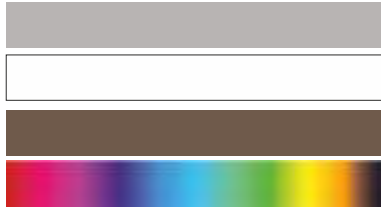

Renkler / Colors

Pres / Pres

Beyaz / White

Kahverengi / Brown

Özel Ral Renkler / Special Ral Colors

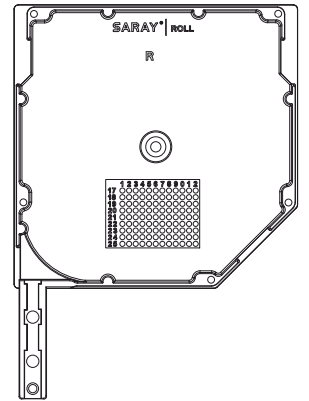

180 mm Alüminyum Yan Kapak

180 mm Aluminium Side Frames

Kodlar / Codes

SAS.180.01.0000

SAS.180.01.9016

SAS.180.01.8014

SAS.180.01.XXXX

(XXXX Ral codu yazınız, Write Ral Code)

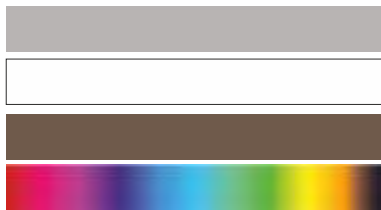

Renkler / Colors

Pres / Pres

Beyaz / White

Kahverengi / Brown

Özel Ral Renkler / Special Ral Colors

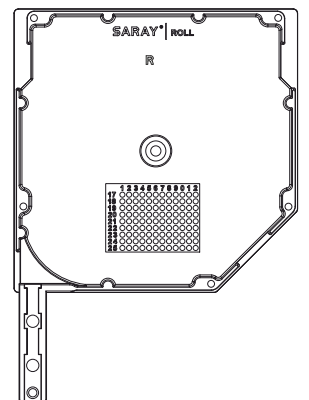

205 mm Alüminyum Yan Kapak

205 mm Aluminium Side Frames

Kodlar / Codes

SAS.205.01.0000

SAS.205.01.9016

SAS.205.01.8014

SAS.205.01.XXXX

(XXXX Ral codu yazınız, Write Ral Code)



Renkler / Colors

Pres / Pres

Beyaz / White

Kahverengi / Brown

Özel Ral Renkler / Special Ral Colors

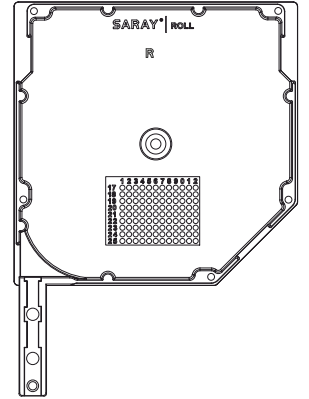

250 mm Alüminyum Yan Kapak

250 mm Aluminium Side Frames

Kodlar / Codes

SAS.250.01.0000

SAS.250.01.9016

SAS.250.01.8014

SAS.250.01.XXXX

(XXXX Ral codu yazınız, Write Ral Code)



Renkler / Colors

Pres / Pres

Beyaz / White

Kahverengi / Brown

Özel Ral Renkler / Special Ral Colors

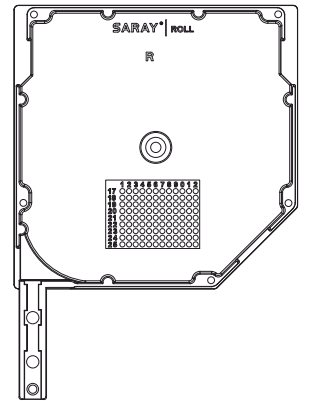

300 mm Galvaniz Çelik Yan Kapak

300 mm Galvanized Steel Side Frame

Kodlar / Codes

SGS.300.01.0000

SGS.300.01.9016

SGS.300.01.XXXX

(XXXX Ral codu yazınız, Write Ral Code)



Renkler / Colors

Pres / Pres

Beyaz / White

Özel Ral Renkler / Special Ral Colors



350 mm Galvaniz Çelik Yan Kapak

350 mm Galvanized Steel Side Frame

Kodlar / Codes

SGS.350.01.0000

SGS.350.01.9016

SGS.350.01.XXXX

(XXXX Ral codu yazınız, Write Ral Code)



Renkler / Colors

Pres / Pres

Beyaz / White

Özel Ral Renkler / Special Ral Colors



400 mm Galvaniz Çelik Yan Kapak

400 mm Galvanized Steel Side Frame

Kodlar / Codes

SGS.400.01.0000

SGS.400.01.9016

SGS.400.01.XXXX

(XXXX Ral codu yazınız, Write Ral Code)



Renkler / Colors

Pres / Pres

Beyaz / White

Özel Ral Renkler / Special Ral Colors



40 mm - 60 mm Boru Başı Rulmanlı Plastik

40 mm - 60 mm Tube Head With Roller Bearing Plastic

**Özellikler / Properties**

Ürün Kodu Product Code	Renk Color	Paketteki Adet Pieces per Package
TPR.040.28.0103	Siyah / Black	50 Adet / Pieces
TPR.060.42.0054	Siyah / Black	50 Adet / Pieces

40 mm - 60 mm - 70 mm Boru Başı Pimli Plastik

40 mm - 60 mm - 70 mm Tube Head With Pim Plastic

**Özellikler / Properties**

Ürün Kodu Product Code	Renk Color	Paketteki Adet Pieces per Package
TPP.040.12.0047	Siyah / Black	50 Adet / Pieces
TPP.060.12.0065	Siyah / Black	50 Adet / Pieces
TPP.070.12.0065	Siyah / Black	50 Adet / Pieces

70 mm Boru Başı Pimli Alüminyum

70 mm Tube Head Striped Aluminium



Özellikler / Properties

Ürün Kodu Product Code	Renk Color	Paketteki Adet Pieces per Package
TAP.070.12.0051	Siyah / Black	50 Adet / Pieces

40 mm'den 60 mm'e Çeviren Adaptör

Adapter to Convert 40 mm to 60 mm



Özellikler / Properties

Ürün Kodu Product Code	Renk Color	Paketteki Adet Pieces per Package
TAA.040.00.0000	Siyah / Black	50 Adet / Pieces

130 mm - 190 mm Çelik Askı Yarıklı

130 mm - 190 mm Steel Hanger With Slot

**Özellikler / Properties**

Ürün Kodu Product Code	Renk Color	Paketteki Adet Pieces per Package
HSS.039.YR.0130		250 Adet / Pieces
HSS.077.YR.0190		250 Adet / Pieces

130 mm - 190 mm Çelik Askı Vidalı

130 mm - 190 mm Steel Hanger

**Özellikler / Properties**

Ürün Kodu Product Code	Renk Color	Paketteki Adet Pieces per Package
HSS.039.VD.0130		250 Adet / Pieces
HSS.039.VD.0190	Siyah / Black	250 Adet / Pieces

Güvenlik Askısı 1 Bakla - 2 Bakla - 3 Bakla

Security Lock For Slot 1 Hole - 2 Hole - 3 Hole

**Özellikler / Properties**

Ürün Kodu Product Code	Renk Color	Paketteki Adet Pieces per Package
GSS.039.1B.9005	Siyah / Black	25 Adet / Pieces
GSS.039.2B.9005	Siyah / Black	25 Adet / Pieces
GSS.039.3B.9005	Siyah / Black	25 Adet / Pieces

48 mm Tabanlı 60 mm - 80 mm Uzunluklu Kıl Fital

48 mm Base 60 mm - 80 mm Lenght Brush Strip

**Özellikler / Properties**

Ürün Kodu Product Code	Renk Color	Paketteki Adet Pieces per Package
KFF.048.PS.0060	Gri / Grey	1600 m
KFF.048.PS.0080	Gri / Grey	1100 m

67 mm Tabanlı 60 mm - 80 mm - 100 mm Uzunluklu Kıl Fital

67 mm Base 60 mm - 80 mm - 100 mm Lenght Brush Strip

**Özellikler / Properties**

Ürün Kodu Product Code	Renk Color	Paketteki Adet Pieces per Package
KFF.067.PS.0060	Gri / Grey	1300 m
KFF.067.PS.0080	Gri / Grey	900 m
KFF.067.PS.0100	Gri / Grey	500 m

50 mm Alt Parça İin Hortum Conta

Hose Rubber For 50 mm End Slat

**Özellikler / Properties**

Ürün Kodu Product Code	Renk Color	Paketteki Adet Pieces per Package
CEH.050.00.9005	Siyah / Black	500 m

55 mm Alt Parça İin Hortum Conta

Hose Rubber For 55 mm End Slat

**Özellikler / Properties**

Ürün Kodu Product Code	Renk Color	Paketteki Adet Pieces per Package
CEH.055.00.9005	Siyah / Black	250 m

84 mm Alt Parça İin Hortum Conta

Hose Rubber For 84 mm End Slat

**Özellikler / Properties**

Ürün Kodu Product Code	Renk Color	Paketteki Adet Pieces per Package
CEH.084.00.9005	Siyah / Black	90 m

100x100 mm'lik Pimli Motor Braket

100x100 mm Motor Bracket With Pim

**Özellikler / Properties**

Ürün Kodu Product Code	Renk Color	Paketteki Adet Pieces per Package
MBP.100.00.0000	Metal Rengi / Metal Color	100 Adet / Pieces

100x100 mm'lik Pimsiz Motor Braket

100x100 mm Motor Bracket Without Pim

**Özellikler / Properties**

Ürün Kodu Product Code	Renk Color	Paketteki Adet Pieces per Package
MBS.100.00.0000	Metal Rengi / Metal Color	100 Adet / Pieces

100x100 mm 42'lik Rulman Yatağı Kare

100x100 mm Bearing Ball For 42 mm Square

**Özellikler / Properties**

Ürün Kodu Product Code	Renk Color	Paketteki Adet Pieces per Package
RYA.100.04.0042	Metal Rengi / Metal Color	100 Adet / Pieces

56 mm 42'lik Rulman Yatağı Ay Şekli

56 mm Bearing Ball For 42 mm Moon Type

**Özellikler / Properties**

Ürün Kodu Product Code	Renk Color	Paketteki Adet Pieces per Package
RYA.056.02.0042	Metal Rengi / Metal Color	200 Adet / Pieces

42x12 mm Metal Rulman

42x12 mm Metal Roller

**Özellikler / Properties**

Ürün Kodu Product Code	Renk Color	Paketteki Adet Pieces per Package
RRS.042.12.0000	Metal Rengi / Metal Color	200 Adet / Pieces

28x12 mm Metal Rulman

28x12 mm Metal Roller

**Özellikler / Properties**

Ürün Kodu Product Code	Renk Color	Paketteki Adet Pieces per Package
RRS.028.12.0000	Metal Rengi / Metal Color	200 Adet / Pieces

42x12 mm Plastik Rulman

42x12 mm Plastic Roller

**Özellikler / Properties**

Ürün Kodu Product Code	Renk Color	Paketteki Adet Pieces per Package
RRP.042.12.0000	Metal Rengi / Metal Color	200 Adet / Pieces

28x12 mm Plastik Rulman

28x12 mm Plastic Roller

**Özellikler / Properties**

Ürün Kodu Product Code	Renk Color	Paketteki Adet Pieces per Package
RRP.028.12.0000	Metal Rengi / Metal Color	100 Adet / Pieces

150 mm Plastik Otomatik Makara

150 mm Plastic Automatic Tape Coiler

**Özellikler / Properties**

Ürün Kodu Product Code	Renk Color	Paketteki Adet Pieces per Package
OMM.150.PL.9016	Beyaz / White	50 Adet / Pieces
OMM.150.PL.7016	Antrasit Gri / Anthracite	50 Adet / Pieces
OMM.150.PL.8014	Kahverengi / Brown	50 Adet / Pieces

196 mm Plastik Otomatik Makara

196 mm Plastic Automatic Tape Coiler

**Özellikler / Properties**

Ürün Kodu Product Code	Renk Color	Paketteki Adet Pieces per Package
OMM.196.PL.9016	Beyaz / White	50 Adet / Pieces
OMM.196.PL.7016	Antrasit Gri / Anthracite	50 Adet / Pieces
OMM.196.PL.8014	Kahverengi / Brown	50 Adet / Pieces

16 mm Dış Kordon Geçiş Yüksüğü

16 mm Outside Strap Guide

**Özellikler / Properties**

Ürün Kodu Product Code	Renk Color	Paketteki Adet Pieces per Package
KGY.016.PL.9016	Beyaz / White	250 Adet / Pieces
KGY.016.PL.7016	Antrasit Gri / Anthracite	250 Adet / Pieces
KGY.016.PL.8014	Kahverengi / Brown	250 Adet / Pieces

16 mm İç Kordon Geçiş Yüksüğü

16 mm Inside Strap Guide

**Özellikler / Properties**

Ürün Kodu Product Code	Renk Color	Paketteki Adet Pieces per Package
KDY.016.PL.9016	Beyaz / White	250 Adet / Pieces
KDY.016.PL.7016	Antrasit Gri / Anthracite	250 Adet / Pieces
KDY.016.PL.8014	Kahverengi / Brown	250 Adet / Pieces

40 mm Plastik Stoper
40 mm Plastic Stopper**Özellikler / Properties**

Ürün Kodu Product Code	Renk Color	Paketteki Adet Pieces per Package
STP.040.PL.9016	Beyaz / White	250 Adet / Pieces
STP.040.PL.7016	Antrasit Gri / Anthracite	250 Adet / Pieces
STP.040.PL.8014	Kahverengi / Brown	250 Adet / Pieces

50-55 mm'lik Yan Dikmeler İçin Akış Aralığı Plastik
50-55 mm Entry Guides For Guide Channel Plastic**Özellikler / Properties**

Ürün Kodu Product Code	Renk Color	Paketteki Adet Pieces per Package
DUP.050.PL.9016	Beyaz / White	100 Adet / Pieces
DUP.055.PL.9016	Beyaz / White	100 Adet / Pieces

77 mm'lik L Makara
77 mm L Roller**Özellikler / Properties**

Ürün Kodu Product Code	Renk Color	Paketteki Adet Pieces per Package
LMA.077.00.0000	Beyaz / White	100 Adet / Pieces

Redüktör Çıkış Mafsallı 50 cm Zamak
50 cm Zinc Joint Plate**Özellikler / Properties**

Ürün Kodu Product Code	Renk Color	Paketteki Adet Pieces per Package
RDC.000.MF.0500	Beyaz / White	10 Adet / Pieces

Redüktör Kolu Mafsallı 150 cm - 200 cm
Joint Plate Handle 150 cm - 200 cm**Özellikler / Properties**

Ürün Kodu Product Code	Renk Color	Paketteki Adet Pieces per Package
RDK.000.MF.1500	Beyaz / White	10 Adet / Pieces
RDK.000.MF.2000	Beyaz / White	10 Adet / Pieces

SARAY[®] | ROLL

S-MONOBLOK
S-MONOBLOCK



197 mm x 197 mm Monoblok Kutu PVC

197 mm x 197 mm PVC Monoblock Box

Özellikler / Properties

Standart Üretim Boyu Standart Manufacturing Length	6,500 mm
Paketteki Adet Pieces per Package	5 Adet / pieces

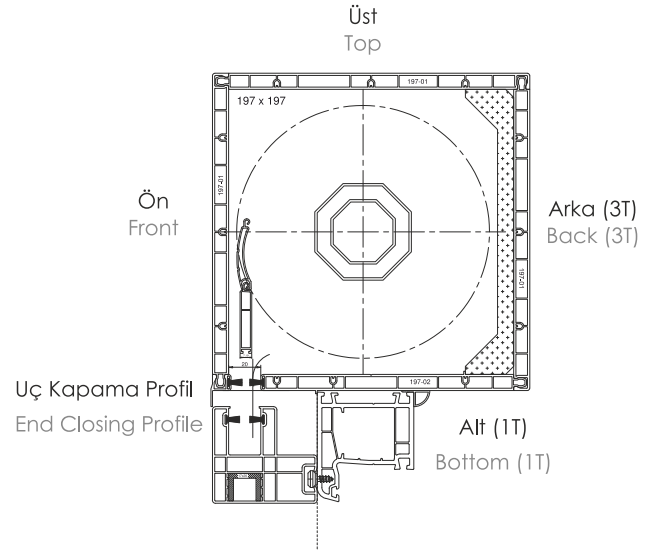

Ön - Üst - Arka Profil / Front - Top - Back Profile

Kodlar / Codes

MNB.197.3T.9016

MNB.197.3T.LC01

MNB.197.3T.LC02

MNB.197.3T.LC03

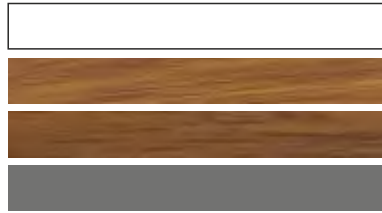

Renkler / Colors

Beyaz / White

Altın Meşe / Golden Oak

Ceviz / Walnut

Antrasit Gri / Anthracite

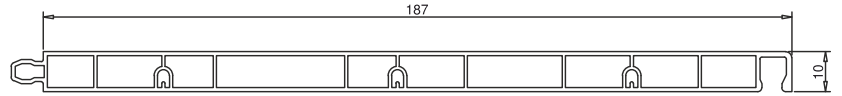

Alt Profil / Bottom Profile

Kodlar / Codes

MNB.197.1T.9016

MNB.197.1T.LC01

MNB.197.1T.LC02

MNB.197.1T.LC03



Renkler / Colors

Beyaz / White

Altın Meşe / Golden Oak

Ceviz / Walnut

Antrasit Gri / Anthracite

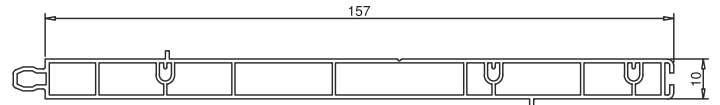

Uç Kapama Profili / End Closing Profile

Kodlar / Codes

MNB.000.UP.9016

MNB.000.UP.LC01

MNB.000.UP.LC02

MNB.000.UP.LC03



Renkler / Colors

Beyaz / White

Altın Meşe / Golden Oak

Ceviz / Walnut

Antrasit Gri / Anthracite



250 mm x 250 mm Monoblok Kutu PVC

250 mm x 250 mm Monoblock Box PVC

Özellikler / Properties

Standart Üretim Boyu Standart Manufacturing Length	6,500 mm
Paketteki Adet Pieces per Package	5 Adet / pieces

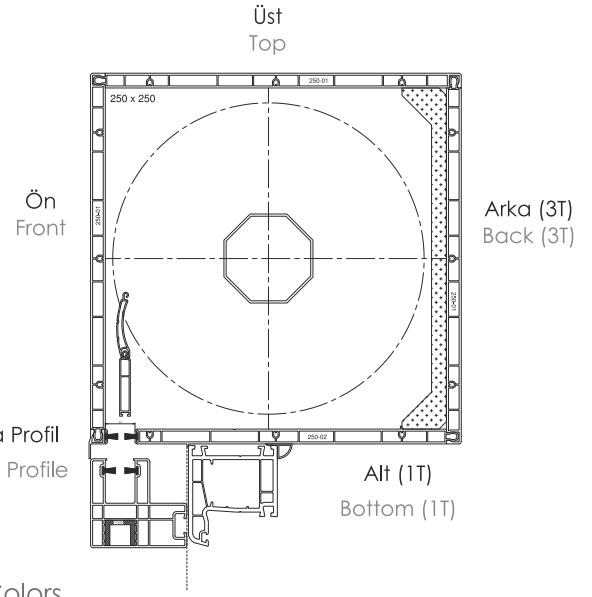

Ön - Üst - Arka Profil / Front - Top - Back Profile

Kodlar / Codes

MNB.250.3T.9016

MNB.250.3T.LC01

MNB.250.3T.LC02

MNB.250.3T.LC03

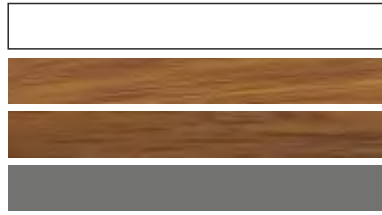

Renkler / Colors

Beyaz / White

Altın Meşe / Golden Oak

Ceviz / Walnut

Antrasit Gri / Anthracite

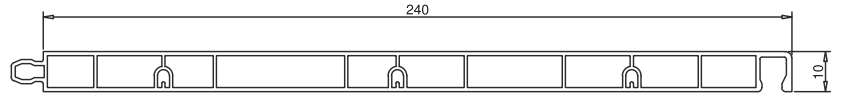

Alt Profil / Bottom Profile

Kodlar / Codes

MNB.250.1T.9016

MNB.250.1T.LC01

MNB.250.1T.LC02

MNB.250.1T.LC03

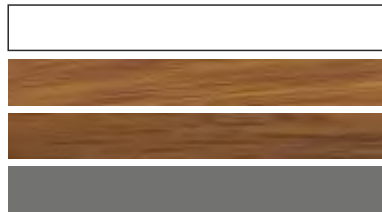

Renkler / Colors

Beyaz / White

Altın Meşe / Golden Oak

Ceviz / Walnut

Antrasit Gri / Anthracite

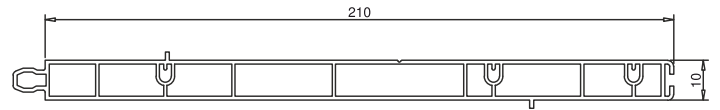

Uç Kapama Profili / End Closing Profile

Kodlar / Codes

MNB.000.UP.9016

MNB.000.UP.LC01

MNB.000.UP.LC02

MNB.000.UP.LC03

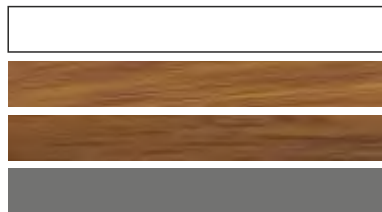

Renkler / Colors

Beyaz / White

Altın Meşe / Golden Oak

Ceviz / Walnut

Antrasit Gri / Anthracite



197 mm x 197 mm Monoblok Kutu Set
197 mm x 197 mm Monoblock Box Set

Özellikler / Properties

Standart Üretim Boyu Standart Manufacturing Length	6,500 mm
Paketteki Adet Pieces per Package	1 Set 5 Parça / 1 Set 5 Pieces

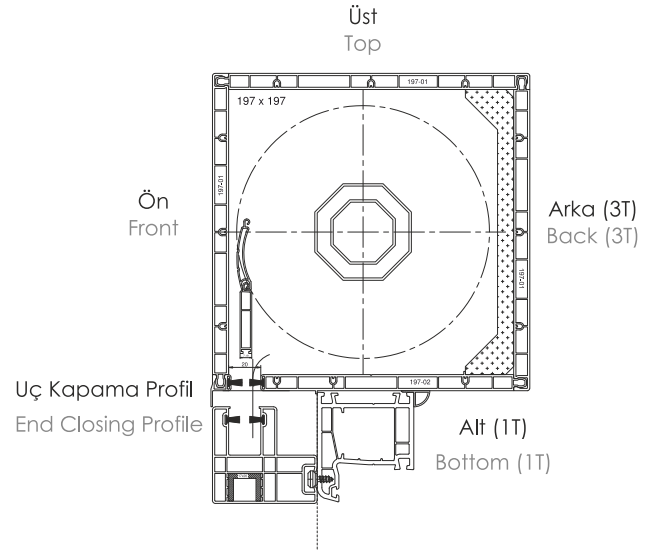

Set / Set

Kodlar / Codes

MNS.197.05.9016
MNS.197.05.LC01
MNS.197.05.LC02
MNS.197.05.LC03

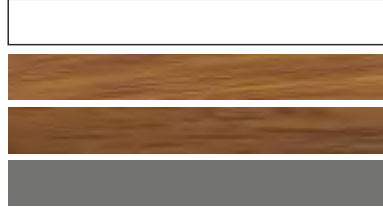

Renkler / Colors

Beyaz / White
Lamineli Altın Meşe / Laminated Golden Oak
Lamineli Ceviz / Laminated Walnut
Lamineli Antrasit Gri / Laminated Anthracite Grey

Set 5 Parça Profilden Oluşur / Set Is Occured From 5 Profile

Kodlar / Codes

MNB.197.3T.XXXX
MNB.197.1T.XXXX
MNB.000.UP.XXXX

Parça Sayısı / Piece Quantity

3 Parça / Pieces
1 Parça / Piece
1 Parça / Piece

250 mm x 250 mm Monoblok Kutu Set
250 mm x 250 mm Monoblock Box Set

Özellikler / Properties

Standart Üretim Boyu Standart Manufacturing Length	6,500 mm
Paketteki Adet Pieces per Package	1 Set 5 Parça / 1 Set 5 Pieces

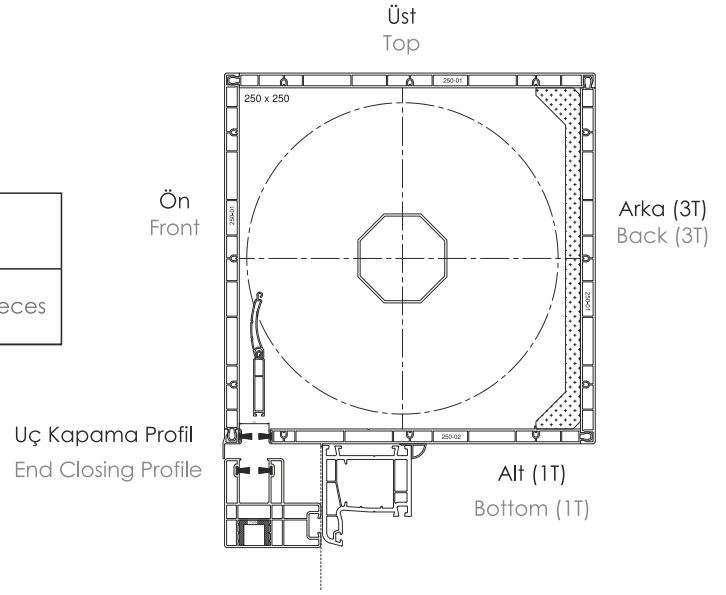

Set / Set

Kodlar / Codes

MNS.250.05.9016
MNS.250.05.LC01
MNS.250.05.LC02
MNS.250.05.LC03

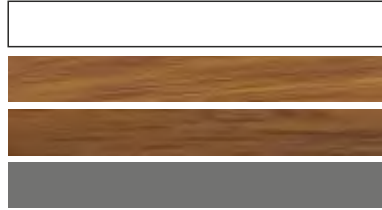

Renkler / Colors

Beyaz / White
Lamineli Altın Meşe / Laminated Golden Oak
Lamineli Ceviz / Laminated Walnut
Lamineli Antrasit Gri / Laminated Anthracite Grey

Set 5 Parça Profilden Oluşur / Set Is Occured From 5 Profile

Kodlar / Codes

MNB.250.3T.XXXX
MNB.250.1T.XXXX
MNB.000.UP.XXXX

PARÇA SAYISI / PIECE QUANTITY

3 Parça / Pieces
1 Parça / Piece
1 Parça / Piece

60 mm Monoblok Yan Raylar
60 mm Monoblock Side Guides

Özellikler / Properties

Standart Üretim Boyu Standart Manufacturing Length	6,500 mm
Paketteki Adet Pieces per Package	6 boy / bars (39mt)

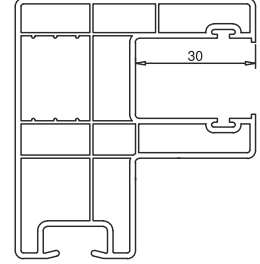

Kodlar / Codes

MNB.060.YR.9016



MNB.060.YR.LC01



MNB.060.YR.LC02



MNB.060.YR.LC03



Renkler / Colors

Beyaz / White

Altın Meşe / Golden Oak

Ceviz / Walnut

Antrasit Gri / Anthracite

80 mm Monoblok Çift Kanallı Raylar
80 mm Monoblock Double Side Guide

Özellikler / Properties

Standart Üretim Boyu Standart Manufacturing Length	6,500 mm
Paketteki Adet Pieces per Package	6 boy / bars (39mt)

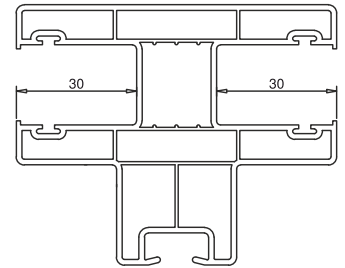

Kodlar / Codes

MNB.080.YR.9016



MNB.080.YR.LC01



MNB.080.YR.LC02



MNB.080.YR.LC03



Renkler / Colors

Beyaz / White

Altın Meşe / Golden Oak

Ceviz / Walnut

Antrasit Gri / Anthracite

197 mm Monoblok Yan Kapak

197 mm Monoblock Side Cap

Özellikler / Properties

Paketeki Adet
Pieces per Package

50 Adet / pieces

Kodlar / Codes

MNA.197.YK.9016

MNA.197.YK.7016

MNA.197.YK.8014

Renkler / Colors

Beyaz / White

Antrasit Gri / Anthracite

Kahverengi / Brown

197 mm Monoblok Sabit Orta Bölme

197 mm Monoblock Fixed Separator

Özellikler / Properties

Paketeki Adet
Pieces per Package

10 Adet / pieces

Kodlar / Codes

MNA.197.OB.9016

MNA.197.OB.7016

MNA.197.OB.8014

Renkler / Colors

Beyaz / White

Antrasit Gri / Anthracite

Kahverengi / Brown

197 mm Monoblok Hareketli Orta Bölme

197 mm Monoblock Movable Fixed Separator

Özellikler / Properties

Paketeki Adet
Pieces per Package

10 Adet / pieces

Kodlar / Codes

MNA.197.HB.9016

MNA.197.HB.7016

MNA.197.HB.8014

Renkler / Colors

Beyaz / White

Antrasit Gri / Anthracite

Kahverengi / Brown

197 mm Monoblok İç Kapak Kapağı

197 mm Monoblock Inside Caps Cap

Özellikler / Properties

Paketteki Adet
Pieces per Package

50 Adet / pieces

Kodlar / Codes

MNA.197.IK.9016

MNA.197.IK.7016

MNA.197.IK.8014

Renkler / Colors

Beyaz / White

Antrasit Gri / Anthracite

Kahverengi / Brown

197 mm Monoblok Kapağın Kapağı

197 mm Monoblock Caps Cap

Özellikler / Properties

Paketteki Adet
Pieces per Package

50 Adet / pieces

Kodlar / Codes

MNA.197.KK.9016

MNA.197.KK.7016

MNA.197.KK.8014

Renkler / Colors

Beyaz / White

Antrasit Gri / Anthracite

Kahverengi / Brown

250 mm Monoblok Yan Kapak

250 mm Monoblock Side Cap

Özellikler / Properties

Paketteki Adet Pieces per Package	50 Adet / pieces
--------------------------------------	------------------

Kodlar / Codes

MNA.250.YK.9016

MNA.250.YK.7016

MNA.250.YK.8014

Renkler / Colors

Beyaz / White

Antrasit Gri / Anthracite

Kahverengi / Brown

250 mm Monoblok Sabit Orta Bölme

250 mm Monoblock Fixed Separator

Özellikler / Properties

Paketteki Adet Pieces per Package	10 Adet / pieces
--------------------------------------	------------------

Kodlar / Codes

MNA.250.OB.9016

MNA.250.OB.7016

MNA.250.OB.8014

Renkler / Colors

Beyaz / White

Antrasit Gri / Anthracite

Kahverengi / Brown

250 mm Monoblok Hareketli Orta Bölme

250 mm Monoblock Movable Fixed Separator

Özellikler / Properties

Paketteki Adet Pieces per Package	10 Adet / pieces
--------------------------------------	------------------

Kodlar / Codes

MNA.250.HB.9016

MNA.250.HB.7016

MNA.250.HB.8014

Renkler / Colors

Beyaz / White

Antrasit Gri / Anthracite

Kahverengi / Brown

250 mm Monoblok İç Kapak Kapağı

250 mm Monoblock Inside Caps Cap

Özellikler / Properties

Paketteki Adet
Pieces per Package

50 Adet / pieces

Kodlar / Codes

MNA.250.IK.9016

MNA.250.IK.7016

MNA.250.IK.8014

Renkler / Colors

Beyaz / White

Antrasit Gri / Anthracite

Kahverengi / Brown

250 mm Monoblok Kapağın Kapağı

250 mm Monoblock Caps Cap

Özellikler / Properties

Paketteki Adet
Pieces per Package

50 Adet / pieces

Kodlar / Codes

MNA.250.KK.9016

MNA.250.KK.7016

MNA.250.KK.8014

Renkler / Colors

Beyaz / White

Antrasit Gri / Anthracite

Kahverengi / Brown

Monoblok Kızak
Monoblock Sled

Özellikler / Properties

Paketteki Adet
Pieces per Package

50 Adet / pieces

Kodlar / Codes

MNA.000.BZ.9005

Renkler / Colors

Siyah / Black

Monoblok Hareketli Kızak
Monoblock Movable Sled

Özellikler / Properties

Paketteki Adet
Pieces per Package

50 Adet / pieces

Kodlar / Codes

MNA.000.RZ.9005

Renkler / Colors

Siyah / Black

Monoblok Orta Kızak
Monoblock Middle Sled

Özellikler / Properties

Paketteki Adet
Pieces per Package

50 Adet / pieces

Kodlar / Codes

MNA.000.OZ.9005

Renkler / Colors

Siyah / Black

Monoblok Kordon Geçiş Yüksüğü

Monoblock Strap Guide

Özellikler / Properties

Paketteki Adet
Pieces per Package

50 Adet / pieces

Kodlar / Codes

MNA.000.GY.9016

MNA.000.GY.7016

MNA.000.GY.8014

Renkler / Colors

Beyaz / White

Antrasit Gri / Anthracite

Kahverengi / Brown

Monoblok Top Başlı Ray Vidası

Monoblock Round Cap Screw

Özellikler / Properties

Paketteki Adet
Pieces per Package

1000 Adet / pieces

Kodlar / Codes

MNA.000.TV.0000

Renkler / Colors

Metalik Gri / Metallic Grey

Monoblok Kutu Bağlama Laması

Monoblock Box Connected Plate

Özellikler / Properties

Paketteki Adet
Pieces per Package

100 Adet / pieces

Kodlar / Codes

MNA.000.BL.0000

Renkler / Colors

Metalik Gri / Metallic Grey

Monoblock Akış Aralığı

Monoblock Entry Guide Slad

Özellikler / Properties

Paketteki Adet
Pieces per Package

50 Çift / Pair
50 sağ-50 sol / 50 right-50 left

Kodlar / Codes

MNA.000.AK.9005

Renkler / Colors

Siyah / Black

Monoblock Klipsli Rulman Yatağı PVC

Monoblock Bearing Cover with Clips PVC

Özellikler / Properties

Paketteki Adet
Pieces per Package

100 Adet / Pieces

Kodlar / Codes

MNA.000.RY.9005

Renkler / Colors

Siyah / Black

197 mm Monoblok Aksesuar Seti

197 mm Monoblock Accessories Set

Özellikler / Properties

Paketteki Adet Pieces per Package	20 Set / Pieces
--------------------------------------	-----------------

Kodlar / Codes

MAS.197.00.9016

MAS.197.00.7016

MAS.197.00.8014

Renkler / Colors

Beyaz / White

Antrasit Gri / Anthracite

Kahverengi / Brown

Set İçeriği Beyaz İçin / Set Index for White

MNA.197.YK.9016	Beyaz 2 Adet / White 2 Pieces
MNA.197.IK.9016	Beyaz 2 Adet / White 2 Pieces
MNA.197.KK.9016	Beyaz 2 Adet / White 2 Pieces
MNA.197.BZ.9005	Siyah 2 Adet / Black 2 Pieces
MNA.197.AK.9005	Siyah 1 Çift (sağ-sol) / Black 1 Pair (right-left)
MNA.197.RY.9005	Siyah 2 Adet / Black 2 Pieces

250 mm Monoblok Aksesuar Seti

250 mm Monoblock Accessories Set

Özellikler / Properties

Paketteki Adet Pieces per Package	20 Set / pieces
--------------------------------------	-----------------

Kodlar / Codes

MAS.250.00.9016

MAS.250.00.7016

MAS.250.00.8014

Renkler / Colors

Beyaz / White

Antrasit Gri / Anthracite

Kahverengi / Brown

Set içeriği beyaz için / Set Index For White

MNA.250.YK.9016	Beyaz 2 Adet / White 2 Pieces
MNA.250.IK.9016	Beyaz 2 Adet / White Pieces
MNA.250.KK.9016	Beyaz 2 Adet / White Pieces
MNA.250.BZ.9005	Siyah 2 Adet / Black 2 Pieces
MNA.250.AK.9005	Siyah 1 Çift (sağ-sol) / Black 2 Pair (right-left)
MNA.250.RY.9005	Siyah 2 Adet / Black 2 Pieces

AKILLI PANJURLAR
INTELLIGENT SHUTTERS

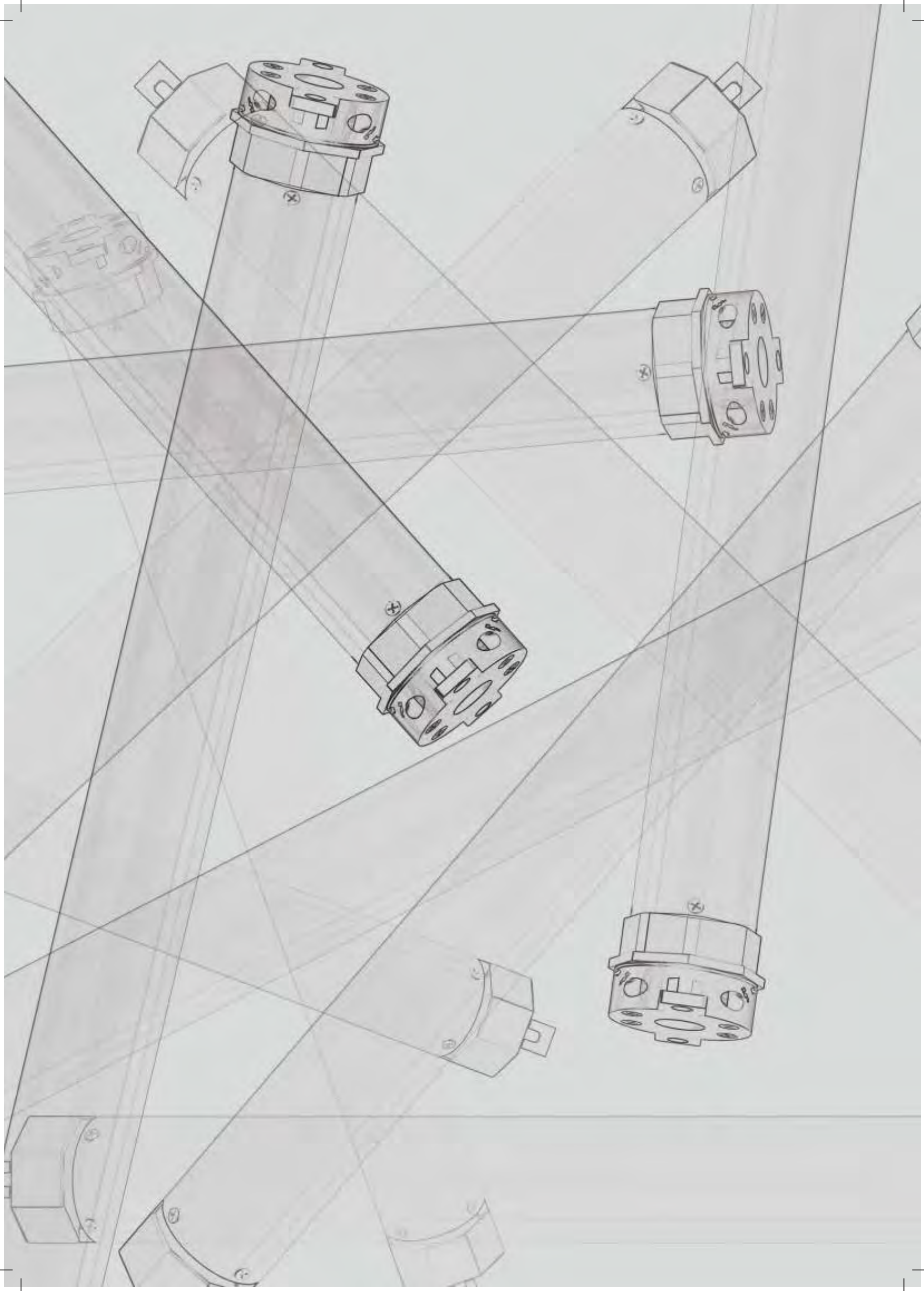

SARAY[®] | ROLL

S-MOTOR

S-MOTOR

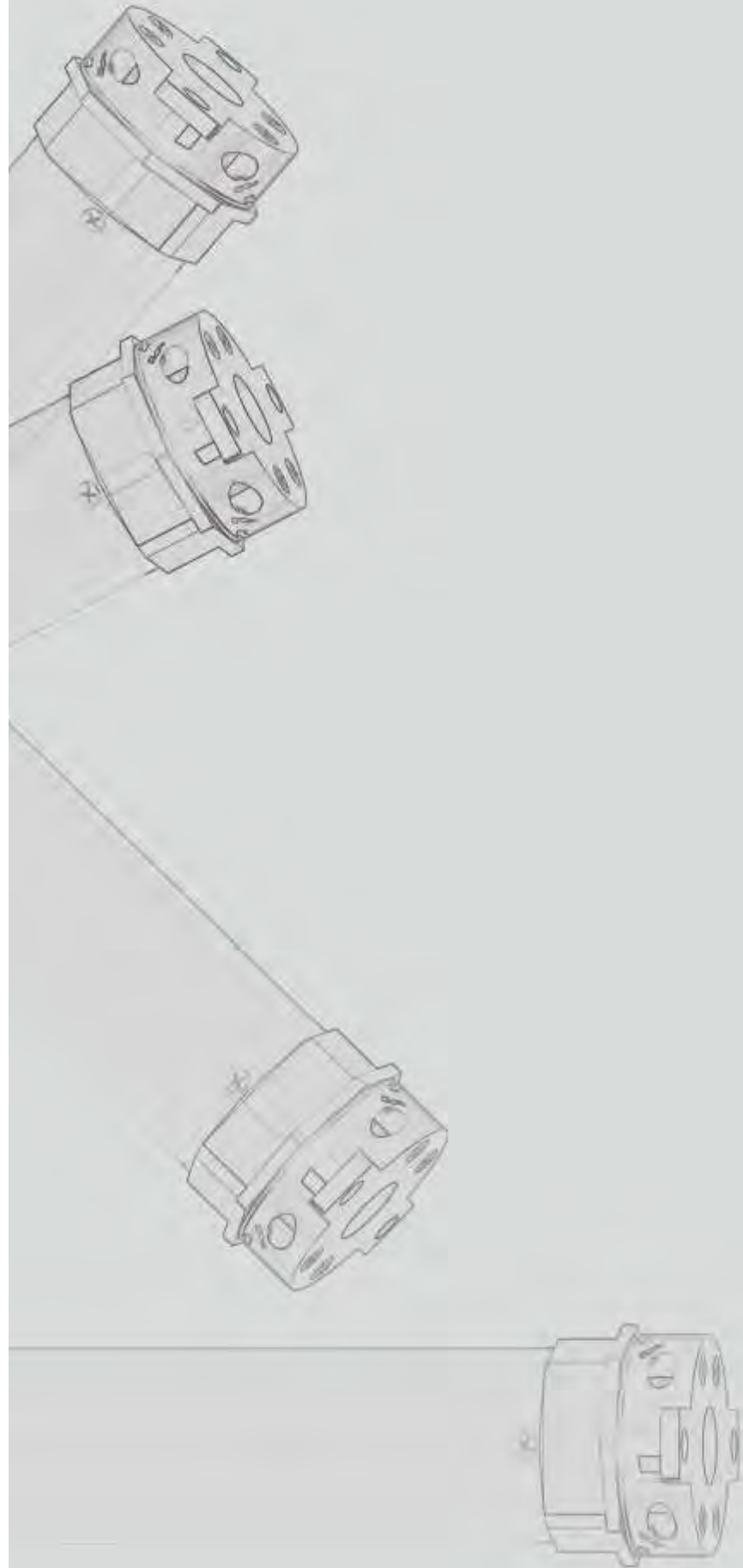

Ø40 mm'lik SARAYROLL Düz Motor

SARAYROLL Standard Tubular Motor Ø40 mm



Ürün Kodu Product Code	Tork Torque (Nm)	Hız Speed (rpm)	Güç Power (w)	Akım Current (A)	Çalışma Süresi Running Time (Dak.-min)	Uzunluk Length (mm)	Ağırlık Weight (kg)
MTR.040.DD.0010	10	15	115	0,50	4	470	1,25

Ø40 mm'lik SARAYROLL Alıcılı Motor

SARAYROLL Motor Radio Ø40 mm



Ürün Kodu Product Code	Tork Torque (Nm)	Hız Speed (rpm)	Güç Power (w)	Akım Current (A)	Çalışma Süresi Running Time (Dak.-min)	Uzunluk Length (mm)	Ağırlık Weight (kg)
MTR.040.AA.0010	10	15	115	0,50	4	560	1,35

Ø60 mm'lik SARAYROLL Düz Motor

SARAYROLL Standard Tubular Motor Ø60 mm



Ürün Kodu Product Code	Tork Torque (Nm)	Hız Speed (rpm)	Güç Power (w)	Akım Current (A)	Çalışma Süresi Running Time (Dak.-min)	Uzunluk Length (mm)	Ağırlık Weight (kg)
MTR.060.DD.0010	10	15	155	0,70	4	470	2,25
MTR.060.DD.0020	20	15	203	0,85	4	470	2,35
MTR.060.DD.0030	30	15	226	0,95	4	470	2,37
MTR.060.DD.0040	40	15	226	0,95	4	470	2,40
MTR.060.DD.0050	50	13	244	1,06	4	470	2,50

Ø60 mm'lik SARAYROLL Alıcılı Motor

SARAYROLL Motor Radio Ø60 mm



Ürün Kodu Product Code	Tork Torque (Nm)	Hız Speed (rpm)	Güç Power (w)	Akım Current (A)	Çalışma Süresi Running Time (Dak.-min)	Uzunluk Length (mm)	Ağırlık Weight (kg)
MTR.060.AA.0010	10	15	155	0,70	4	470	2,25
MTR.060.AA.0020	20	15	203	0,85	4	470	2,35
MTR.060.AA.0030	30	15	226	0,95	4	470	2,37
MTR.060.AA.0040	40	15	226	0,95	4	470	2,40
MTR.060.AA.0050	50	13	244	1,06	4	470	2,50

Ø60 mm'lik SARAYROLL Redüktörlü Motor
SARAYROLL 60 mm Reducer Motor



Ürün Kodu Product Code	Tork Torque (Nm)	Hız Speed (rpm)	Güç Power (w)	Akım Current (A)	Çalışma Süresi Running Time (Dak.-min)	Uzunluk Length (mm)	Ağırlık Weight (kg)
MTR.060.RR.0030	30	17	226	0,95	4	615	3,10
MTR.060.RR.0040	40	17	226	0,95	4	615	3,15
MTR.060.RR.0050	50	13	244	1,06	4	615	3,3

Ø70 mm'lik SARAYROLL Düz Motor

SARAYROLL Standard Tubular Motor Ø70 mm



Ürün Kodu Product Code	Tork Torque (Nm)	Hız Speed (rpm)	Güç Power (w)	Akım Current (A)	Çalışma Süresi Running Time (Dak.-min)	Uzunluk Length (mm)	Ağırlık Weight (kg)
MTR.070.DD.0080	80	12	360	1,6	4	585	4,85
MTR.070.DD.0100	100	12	444	2	4	585	4,85
MTR.070.DD.0120	120	9	444	2	4	585	4,86
MTR.070.DD.0140	140	9	444	2	4	585	4,86

Ø70 mm'lik SARAYROLL Redüktörlü Motor

SARAYROLL 70 mm REDUCER MOTOR



Ürün Kodu Product Code	Tork Torque (Nm)	Hız Speed (rpm)	Güç Power (w)	Akım Current (A)	Çalışma Süresi Running Time (Dak.-min)	Uzunluk Length (mm)	Ağırlık Weight (kg)
MTR.070.RR.0080	80	12	360	1,6	4	635	6,15
MTR.070.RR.0100	100	12	444	2	4	635	6,15
MTR.070.RR.0120	120	9	444	2	4	665	6,16
MTR.00.RR.0140	140	9	444	2	4	665	6,16

AKILLI PANJURLAR
INTELLIGENT SHUTTERS

SARAY

Osmanpaşa Cad. Bağlar Mah. No: 89

Güneşli - İSTANBUL

Tel: +90 212 550 49 47 Faks: +90 212 515 81 00

www.saray.com

